

SECRET

SUBJECT: Potential Informant For CE Activity:

IDENTIFICATION

NAME : KOPP, Walter
DOB : 21 March, 1913, Alsenz, Pfalz
ADDRESS : Buttenwiesen b. Augsburg
OCCUPATION : Engineer, former professional soldier
PROJECT : KIBITZ stay behind
POSITION IN PROJECT: Chief Agent
CLEARANCE STATUS : cleared MCK-W-12241

SHORT BIOGRAPHICAL BACKGROUND: Subject was educated nine years at gymnasium, and started study of science at the University of Munich. He then in 1932 went into the service with the engineers. He was commissioned in 1933 as a Faehnrich, and steadily advanced in a long military career in various fields and numerous theaters, far too long to enumerate here. Most important was his service with the Pioneers on the Eastern front. He ended up as a Colonel and turned himself over to the Americans, released in 1945. Obligated to follow civilian pursuits, he undertook the management of his family businesses, highly successful, which brings him a large independent income. In May 1950 he wrote a letter to then High Commissioner McCloy, and stated that he and a group of his friends were concerned over what might happen in case a Russian invasion and wished to place themselves at the disposal of the Americans. He was interrogated by one of our case officers and since has built a large network of potential stay-behind agents which has since been abandoned by orders from home.

MOTIVATION AND PERSONALITY:

a. Motivation: Unquestionably his militant anti-Communism, pro-Western orientation, and desire to see Germany rid of the Russians. Of the Western powers he likes the U.S. best. He is nationalistic, but supports NATO and the European Army. His experiences in the East have led him to believe that Germany must be spared from Russian domination and saved for the West.

b. Personality: Forceful, dynamic, and energetic. He is a tireless worker and a strong leader. Inclined to rashness, at times, he is held in check by his adjutant and co-worker. Is learned and up-to-date on world affairs, and has a good mind. He is a typical German type and typical professional soldier type, having their faults and virtues.

ASSOCIATION WITH OTHER AGENTS: As chief agent he recruited and controlled a large chain of agents and prospects. He was known to have tremendous influence over his agents and was highly respected by them.

SECURITY EVALUATION AND COMMENTS: The main fault with his operation was that it was not well compartmented. Subject has had a difficult time learning a few tricks of the trade and security measures, but through constant lectures, etc. has improved tremendously. Another fault was that he considers his agents all "good, trustworthy Germans," and hence probably trusted them too much. As it had turned out, this is largely true, but he should never take it for granted. We have been aware of these faults for some time, however, and corrective measures have been taken.

SECRET

NAZI WAR CRIMES DISCLOSURE ACT INFORMATION

EXEMPTIONS Section 3(b)
(2)(A) Privacy
(2)(B) Methods/Sources
(2)(G) Foreign Relations

Declassified and Approved for Release
by the Central Intelligence Agency
Date: 2005

SECRET
SECURITY INFORMATION

REASONS FOR TERMINATION WITH US: Subject is said to be difficult to control. Subject considered himself a "free co-worker" ~~XXXX~~ and not merely an "agent". However, subject was both honest and trustworthy and could very well be capable of obtaining many leads and much information pertaining to counter-intelligence.

Subject has submitted the following information and claims to be able to give more details if requested:

a. Youth groups of the SPD and the unions are in many cases strongly leftist. They have arms in Alzey. There is talk among them that they will cooperate actively with the East after the Americans leave. Eastern agents are definitely working here.

b. In view of the fact that since 1945 police officials have been recruited not only from former conservative but also from anti-nazi circles, it could be observed that in many cases officials of lower rank are strongly oriented towards the left. A confidant reported for instance that the police chief of Alzey though officially an SPD man is in fact close to the KPD. The same circles comment openly on the unreliability of the police in regard to secrecy, even in matters concerning the former State Security Service. This should be food for thought/.

c. One encounters these days--on the doves of the palatinate, among the gypsies and ambulant workers--vagabonds of a type so far unknown. There is open talk about employers, financiers, information and plans. In many cases reporter and his associates have detected among the small type foreigners. Among certain womenfolk, and even among the so-called big-shot officers, traces of a definite organization that gathers information here and reports it.

This has been so obvious in many cases that people have asked themselves the following question: "could it be possible that the Americans really want the East to get all this information? Unless they did, they would certainly undertake counter measures."

d.. Do you want me to go into the matter and prepare a plan for counter-espionage that might bring all sorts of connections into the open?

Subject says that for almost 5 months he has been in constant touch with all strata of the population in the Palatinate, the Hunsrück, Rhein-Hesse and the area of Frankfurt. He believes that his adaptability to the different regions and people has enabled him to get an insight into matters that escape the average observer.

We would be very interested to know if you could use an informant of this type. It is our opinion that subject would submit written reports to you which could expose Communist activity. It is also believed that subject would not request financial obligations or salary but would merely ask for expenses if there should be any involved. We could arrange necessary introduction or rendezvous at your request.

SECRET
SECURITY INFORMATION []

Walter KOPP (KIBITZ-15) (CAPITATION-100) M

Born 21 March 1913, Alsens, Pfalz
Lives in Buttemwiesen bei Augsburg;
Wehrmacht 1932-1945 when turned himself in as American PW; released Jun 45;
Rank of Colonel, 1 Jan 45

(Not to be confused with Walter KOPPE. b. 24 May 1905. Gross Bantzen, Kresl
Teltow; EE/PP/G agent in project [] CO - []
Traces on this Walter turned up by PPG:
MGKA 11296: KOPPE Walter born 21 June 1891, Berlin
Field Investigation: same: principal KPD secretary, Berlin

Polygraph on KIBITZ-15 20 Jan 53
Netative traces POB, 6 Nov 52

WASH 8890, OUT 59911, 5 Jul 50: No probable traces; Dept of the Army captured
Documents noted ~~XXXX~~ (1) professional political
(in KIBITZ-15 file) officer b. 1911, Lt. 1935, missing in action
as Col. 1944 (2) b. 1913, commissioned in engineers
1935, last rank Major

TRACES: 1 April 1953

32-6-2-2662
(MGKA 22348) in file (of no security value)

32-6-2-6910
(MGKW-11977)
T/S CIA 72452 in EE/G file (name mentioned in connection with someone
else

201-20993 *Req. for trace; POB reply - not id.*

100-2-28-1417
Encl. 8 (I&S check) (no info of invest. value or security interest)

32-6-1-1944
(MEKA 21761) (of no security value) *in file*

32-6-1-8079
Encl.
MGFA 6481 (of no security value) *in file*

NAZI WAR CRIMES DISCLOSURE ACT

EXEMPTIONS Section 3(b)

- (2)(A) Privacy
(2)(B) Methods/Sources
(2)(G) Foreign Relations

Declassified and Approved for Release
by the Central Intelligence Agency
Date: 2005

Reports and Information

VIA: _____
SPECIFY AIR OR SEA POUCH

DISPATCH NO. MGK-A-13411

SECRET
CLASSIFICATION

TO : Chief, FDM

DATE: 30 December 1949

FROM : Chief of Station, Karlsruhe *c/req*

SUBJECT: GENERAL - Operational
SPECIFIC - KIBITZ-12 Meeting
HANS H. HORNHAUER *209*

1. The undersigned and [] met with Subject on 10 December 1949 at Subject's home in Hochberg, near Traunstein, Bayern. The purpose of this meeting was to introduce [] to Subject and to give [] an opportunity to make an assessment of Subject's hunting property as to its suitability for safe house and possible location for a radio unit.

2. [] was introduced in no official capacity, only as a hunting acquaintance of the undersigned. [] carried the bulk of the conversation directed toward hunting in general, trying to create common ground for friendship and mutual interests in view of future visits with Subject. It was brought to our attention that Subject has a son who is still a PW in Russia. Subject has heard from returning PW's that members of his son's division, the First Bavarian Division, are being kept in Russia because the division was attached to the SS just prior to its capture by the Russians. Subject has not heard from his son since April and thinks by this time that he must be dead.

3. Inclement weather made a physical inspection of the 3800 acres impossible. Politics or Subject's association with the undersigned were not discussed. Future meetings between [] and Subject will be made purely on a hunter-guide basis up until [] has completed his assessment. One bottle of whiskey and one carton of cigarettes were given to Subject as a Christmas present.

DIST:
~~2 FDM~~
1 KOB
2 COS

IS COPY
SECRET
CLASSIFICATION

REGISTRY COPY *22-1-1950*

FORM NO. 51-28A
MAR 1949

NAZI WAR CRIMES DISCLOSURE ACT

EXEMPTIONS Section 3(b)
(2)(A) Privacy
(2)(B) Methods/Sources
(2)(G) Foreign Relations

Declassified and Approved for Release
by the Central Intelligence Agency
Date: *2005*

INCOMING CLASSIFIED MESSAGE
CENTRAL INTELLIGENCE AGENCY

SECRET

FROM: KARLSRUHE ROUTINE
TO: SPECIAL OPERATIONS 28 JUNE 50
ACTION: FDI (1-2) IN 309dl
INFORMATION: AOSO (3-4), STC (5), IID (6), S/C (7-3-9)

Pamphlets Not Required. Handle as SECRET Correspondence per Para. 41 (1) 414 AR-300.4

KARL 0076

TO: MEIDF, STUTT, TASHF, PULF CITE: KARL

1. EARLY TRACES REQUESTED EX-REICHSDIENR COLONEL WALTER KOPP.
2. FOR YOUR INFORMATION KOPP OFFERED SERVICE OF HIS GROUP OF EX-REICHSDIENR OFFICERS TO HOLLAND.
3. FOR POB: TRACE ALONG WITH PATCH OTHER EX-ARMY OFFICERS.

CONFIDENTIAL

SECRET

NAZI WAR CRIMES DISCLOSURE ACT

- EXEMPTIONS Section 3(b)
- (2)(A) Privacy
 - (2)(B) Methods/Sources
 - (2)(G) Foreign Relations

Declassified and Approved for Release
by the Central Intelligence Agency
Date: 2005

OUTGOING CLASSIFIED MESSAGE

PAGE NO.

CENTRAL INTELLIGENCE AGENCY

DATE: 5 JULY 1960	ROUTINE <input checked="" type="checkbox"/>	PRIORITY <input type="checkbox"/>	URGENT <input type="checkbox"/>
FROM: SPECIAL OPERATIONS	107	1	PHONE EX
TRANSMIT TO: KARLSRUHE	SECRET (CLASSIFICATION)		

TYPE IN CAPITAL LETTERS, DOUBLE SPACED

TO: KARL F CITY: WASH F (4434)

RE: KARL 9076 (IN 3064)

1. NO PROBLEMS TRACE.
2. DEPT OF ARMY CAPTURED DOCUMENTS SHOW WALTER KOPP, PROFESSIONAL POLICE OFFICER, BORN 1911, ORDERED ACTIVE DUTY WEHRMACHT AS LIEUTENANT 1935, MISSING IN ACTION AS COLONEL 1944. ANOTHER WALTER KOPP, BORN 1915, COMMISSIONED IN ENGINEERS 1935, LAST RANK MAJOR.

M 6 02 05 PM

Coded By Machine Work To Machine Work

Read By Machine Work Checked By Machine Work

OPERA
RELEASING OFFICER

COORDINATING OFFICERS

AUTHENTICATING OFFICER

SECRET
(CLASSIFICATION)

NAZI WAR CRIMES DISCLOSURE ACT

- EXEMPTIONS Section 3(b)
- (2)(A) Privacy
 - (2)(B) Methods/Sources
 - (2)(G) Foreign Relations

Declassified and Approved for Release
by the Central Intelligence Agency
Date: 2005

VIA: _____
(SPECIFY AIR OR SEA POUCH)

DISTRIBUTION NO. MGKA-20317

SECRET
CLASSIFICATION

TO : Chief, Foreign Division M

DATE: 5 July 1950

FROM : Chief of Station, Karlsruhe *OKS*

SUBJECT: GENERAL KIBITZ Progress Report

SPECIFIC: Recruitment of KIBITZ 14 L 3

REF: MGKA-20316

General Oper. Matthew Ger.

1. Subject, a former captain in the German Army communications service, now runs a radio repair shop in Stuttgart from where he also is prominent in amateur radio operators circles, from which we plan to recruit communications men for Phase A VULTURE work. First knowledge of the man came through our surveys of the listed licensed amateur radio operators in search of potential recruits. Overt approach in March 1950 was possible through his radio repair shop where L 3 (known as Mr. "Donn") first took "his" radio and later radios of "friends" for repairs, under which guise the innocent contacts were stretched out for a period of four months of observation. The association with Subject on his ground of interest plus his pro-Americanism due to the good treatment he received while an American POW soon saw this contact develop into a pleasant friendship with L 3 being invited into the living quarters above the shop to meet the family consisting of mother, wife, and four year old son.

2. During the developing after-hour coffee and cake visits where Subject demonstrated his excellent self-built radio equipment, the discussions progressed through topics of present day interest including the threat of war with Russia. In this Subject declared himself strongly anti-communist and stated that he and others of his amateur colleagues would unquestionably resist a Russian aggression of Germany. As reports of these developments came in, coupled with L 3 information to the effect that Subject was some sort of an official in authority to administer the examinations necessary to receive an amateur radio operators license, Subject came more and more to filling the pattern of the bird dog we needed to point up other less conspicuous recruits among the ham operators.

3. Name check was requested in MGKA-18708, results of which were all negative. After full evaluation of the man as he would function as a cut-out recruiter among others and therefore not subject to immediate supervision, it was decided to recruit him under the strictest "Germans for Germany" cover. Further, such cover would avoid the risk of Subject taking insult in L 3's ulterior motives in the carefully nurtured friendship. As the time ripened for the recruitment, L 3 set the stage by casually commenting that he had recently attended a social function at EUCOM headquarters where he, in making conversation, had spoken of his new acquaintance in Stuttgart who is so well grounded in radio work and has been making almost impossible repairs (one of the radios we prepared

Dist:
FDM - 2 ✓
REG - 1
KOB - 2

FORM NO. 51-28A
MAR. 1949

SECRET
CLASSIFICATION

22-6-2-2565

NAZI WAR CRIMES DISCLOSURE ACT

- EXEMPTIONS Section 3(b)
- (2)(A) Privacy
 - (2)(B) Methods/Sources
 - (2)(G) Foreign Relations

Declassified and Approved for Release
by the Central Intelligence Agency
Date: 2005

SECRET

for repairs is apparently still beyond repair). These comments of []'s were reportedly of great interest to one of the Americans there [] and he asked to some day meet Subject. With this preparation it was only necessary for [] a few days later to alert Subject for a visit from the interested American. The meeting was set to coincide with []'s recent trip through Stuttgart, 22 June. Although [] is fully familiar with the "Germans for Germany" cover story, a draft of the desired conversation was prepared for him as a briefing.

4. A suitable cafe in Stuttgart was selected for its layout which would offer dimly lit seclusion, and [] was dispatched to pick up Subject and deliver him to [] who was waiting in the cafe. [] introduced [] as [] and, as previously rehearsed, [] was told that a message had come for him and could he be excused to tend to it. That [] would accept responsibility for getting Subject home. After []'s departure, []'s entrance was delayed in order for [] to explain that [] was relieved that [] had to leave inasmuch as the meeting was not actually for the purpose of meeting [] but rather another German whom [] was not to know about. [] further explained that there would be no names mentioned in introduction to the other guest for reasons which Subject would later approve. []'s entrance thus prepared for, he took his place in the meeting, and with a brief comment from [] regarding Subject's reputation as a radio technician, [] went on to explain the views of some thinking Germans who, though they are helpless as all others in meeting the threat of war, realize also that rearmament of western Germany would only precipitate such a war. Rather than, they are of accord in going along with allied policy and can only hope that the western powers would be able to stop the Russian blitz somewhere on the continent from where to start the fight back. In this time and situation, the allies will be needing a communications system into the occupied territory, and such a communications system must be prepared in advance while time and facilities are available to train and test the loyalties of the communications net.

5. Subject went along with the project as it was presented to him with but the one usual objection of family men when they are approached to join such a widow-makers club. However, he was satisfied with an outline of the role outlined for him as recruiter and trainer of other communications men. Under this agreement, [] was excused and [] entered his declared role as liaison between the German organization and the Americans who are supporting and coordinating the activity. Lastly, further consideration was given to Subject's cover at home and with [] who for the time will simulate ignorance of Subject's secret dealings with []. It was finally decided that Subject would report to [] that [] wanted to see him with regard to assisting a young fellow in Stuttgart to become an amateur radio operator. In fact, this can be made true, as there is such a fellow of []'s acquaintance (KIBITZ 3), who is suffering from partial paralysis and therefore is pretty much out of things and who would get a great moral boost out of such an interesting hobby. Subject agreed to take on the young fellow, and thus he will already have begun

SECRET

SECRET

- 3 -

to live his cover as well as get KIBITZ 3 started in learning communications which would otherwise be impossible in that he could never get the necessary six weeks leave from his employment in order to attend MISSOURI. Later, as KIBITZ 3 approaches operational proficiency he can be entered into MISSOURI for the shorter term necessary to teach him the specifics of clandestine operations for us.

6. In any event, this is an entre to the amateur radio operators group, and the recruitment must be credited to Stockdale, who developed the contact from the time when it was just a name among many on a list of over a thousand licensed radio hams.

Ami
for [] []

HR
MAR 2 1950

RECEIVED
MAR 17 1950
MAR 17 1950

SECRET

[] []
~~32-62-2565~~

Walters
2
KOPP, Walter
MCKA- 20591

Chief, ROB
Chief of Station, Karlsruhe
Walter KOPP

18 July 1950

1. Attached is file of correspondence re Subject who has offered the services of a group of his friends, former Reichswehr officers, who are experienced in the economic, political, military and propaganda fields.

2. A request for traces reveals the following:

- (a) Intelligence Division EUCOM reports no record. (HEIDF-2037)
- (b) CIC Central Registry reports no traces. (MCSA-1852)
- (c) Pullach reports no OFFSPRING traces. (PULF-791)
- (d) Washington reports no probable trace. However, they forward the following info on two Walter KOPP's: (WASHF-8890)
 - (1) Dept of Army captured documents show one Walter KOPP, professional police officer, born 1911, ordered active duty Wehrmacht as Lt. 1935, missing in action as Col. 1944.
 - (2) Walter KOPP, born 1913, commissioned in Engineers 1935. Last rank Major.
- (e) Karl files reveal no probable traces.

3. Per suggestion on attached buckslip, file is forwarded for your perusal in connection with stay-behind possibilities.

Distribution:
2 ROB w/attachment
1 COS/B

NAZI WAR CRIMES DISCLOSURE ACT

- EXEMPTIONS Section 3(b)
- (2)(A) Privacy
 - (2)(B) Methods/Sources
 - (2)(G) Foreign Relations

Declassified and Approved for Release
by the Central Intelligence Agency
Date: 2005

AIR

SECRET

MGE-A-21761

Chief, Foreign Division M
Chief of Station, Karlsruhe
Operational
KIBITZ - Walter KOPP

240
check OK

18 August 1950

1. Introduction to Subject was through his letter 1 May 1950 to US High Commissioner MCCLOY, which was forwarded to [] by HICOG, Office of Intelligence. Summary translation of KOPP's letter is given below:

"Writer, representing the interests of a group of his friends, former Reichswehr-officers, among them experienced combat men, experts in technical, tactical and diplomatic fields as well as persons thoroughly familiar with areas in the Balkans, Russia, the Caucasian mountains etc., offers to put his and his friends' services at the disposal of the Americans.

"Writer continues saying that all of his friends have found new employments and manage to get along fine, that they, however, in due consideration of the traditional western occidental culture deem it their duty - should their services be required at all - to offer their versatile experiences in the economical, propagandistic, political and military fields. Writer believes that it will be hard to understand for a citizen of the "New World" when he says that it is his and his friends' conception of honor that makes them take this quite unusual step, the result of the present entangled political situation.

"Writer does not expect a reply to his letter hopes, however, that his offer will be remembered in due time."

2. This proposal gave grounds for consideration of Subject, or some of his friends, for some form of stay-behind activity. Due to Subject's given address in the French Zone, we had particularly counted on making the development among his friends as soon as they became known. However, as it later develops we find Subject has a family residence near Augsburg in the American Zone and that the address Alsenz/Rheinpfalz is one of his business addresses. However, the first contact was made at the French Zone address where we located him after two previous misses due to his traveling between the two addresses. He was interviewed by [] on 15 August at the Alsenz address. [] used the name of Kessler (as he had done on the previous visits when he spoke to Subject's sister and sister-in-law), and as introduction handed Subject a copy of his own letter to

Distribution:
2 - FDM w/att.
1 - COS w/att.
2 - KOB w/att.

SECRET

NAZI WAR CRIMES DISCLOSURE ACT

EXEMPTIONS Section 3(b)

- (2)(A) Privacy
- (2)(B) Methods/Sources
- (2)(G) Foreign Relations

Declassified and Approved for Release
by the Central Intelligence Agency
Date: 2005

SECRET
- 2 -

MCCLOY. Subject immediately escorted [] to a small office in the upstairs of the family construction material place of business where he reiterated the thoughts expressed in the letter. In essence, Subject feels that the Western powers are now reaching the maturity of anti-Communism that Germany had felt early after World War I and through the present. And as America seems most ready to do something about it, he felt it time to present himself.

3. Subject, though presently self-employed as a tractor sales agency, remains the unreconstructed ram-rod type of professional soldier of the old officer corps, a choice he made as the second son not eligible to inherit the family business and so required to choose another career. He is quite proud in his choice in that candidacy was considered quite an accomplishment at the time when Germany's military program was restricted to 100,000 men and 2,500 (or 2,400) officers. As an example of his professional officer pride: when he was filling out the Personal Record Questionnaire (attached) he good-naturedly griped about the questions to be filled out until he came to item #25 (Military Service). Here he became a changed person and immediately declared the space to be filled in as inadequate, whipped the paper out of the typewriter, turned to the other side of the page and proceeded without hesitation to fill up the full page and three quarters of another, listing in all 38 separate phases of his military career, giving day-month-year accounting from April 1932 until his capture by the Americans (on the last of seven times he was wounded) and release on 29 June 1945 after one month's incarceration. From the PRQ it will be seen that KOPP is perhaps identical with the second person mentioned in paragraph 2 of WASHF-8890.

4. As a basis for discussion [] asked him whether he and his friends had any definite plans with which to follow up his letter to MCCLOY. He replied that they, as others, had no knowledge of what they should do or could be allowed to even think of doing. It was explained to him that the courses open to them were hard to define, and in fact, despite the present conversations of re-arming Germany, there is really nothing to be made of it. However, it would not be ill advised for them to assess their potential and prepare it in a form which [] could present for possible interest by one of the planning agencies. This he agreed to as practical and intimated it would be in the form of a staff report and named the following as his comrades in the project:

Will SCHLEIF, Oberammergau, (opposite Electric works).
Willi GEISSERT, Durlach, Bergbahnstr. 1
Werner REICH, Neuwied-Niederbieber, Schulstr. 7
Otto BUCHHORN, Backnang (Forsthaus)
Helmut STIERLE, Stuttgart, Dresdner Bank
fm RAGEL, Ulm, Bahnhofstr., Neu Ulm
Max KEMERICH, Munich (exact address not known)

Name traces on these persons are being requested by separate memo to CLS, ELS, BOB and FDM.

5. From his conversation it would appear his thinking is in the line of building a military nucleus around an elite police corps except that it might no

SECRET

SECRET

- 3 -

longer be practical in that it might precipitate an international incident. As an alternative, he is thinking of a program for recruiting among former staff members to be secretly organized in some neutral country and continue to develop an army with further recruitment from men drawn out of Germany as a labor force, or send the officers as trained back to Germany to secretly recruit and organize units here. He was asked if this meant he was considering organizing to form an underground army, to which he replied definitely not! The Germans will never respond to such a venture - there will never be an organized (or effective) resistance movement in Germany. In substantiation he cited the Werewolves whose only act was the murder of the Mayor of Aalen (or Aachen).

6. All of his thinking seems to be to an excess of our modest KIBITZ program. Nor do we envisage utilization of such a stern military tactician. However, we will go along with him in the hopes of bending one of his associates as we come to know them. In the meantime, any studies as they might present will be forwarded for others' interest. Our next meeting is tentatively set for 1 September.

[]

SECRET

18 Aug 50

SECRET

PERSONAL RECORD QUESTIONNAIRE

1. Walter KOPP
2. Not applicable
3. Not applicable
4. None
5. a. 21.3.13
b. Alsen-Pfals
6. German
7. Not applicable
8. Buttenwiesen
9. Buttenwiesen bei Augsburg
10. Independent engineer
11. Not applicable
12. Relatives in United States, addresses not known by heart.
13. Karl Albert KOPP, wood dealer, born 24.6.82 in Alsen. Died 18.5.45 in Alsen.
14. Charlotte KOPP nee Fraenger, born 5.2.86 in Lauterecken-Pfals.
15. Erna Maria nee Eisels, born 17.9.13 in Augsburg. Married 28.1.39 in Augsburg, now resident in Pfaffenhofen - Buttenwiesen.
16. Ute Elisabeth KOPP born 14.8.41 in Wertingen
Karl Rüdiger KOPP born 6.5.43 in Wertingen
Now residing with their parents.
17. Ruth Karoline Mumd nee KOPP, Alsen
Werner - Wilhelm KOPP, Alsen.
18. Not known
19. German Kennkarte, Wertingen B 06514 v. 7.9.46
20. Reformed Protestant
21. Conservative. Perhaps now represented by CDU circles.

SECRET

NAZI WAR CRIMES DISCLOSURE ACT

Classified and Approved for Release
by the Central Intelligence Agency
date: 5005

SECRET
- 2 -

22. 1927 8 days - Switzerland - leave
1932 5 days - France - leave
1934 5 days - Czechoslovakia - leave and 5 days Austria.
from 1939 - France, Poland, the whole Balkan region, Spain -
in connection with the war.
23. 4 years Volksschule, 9 years humanistic Gymnasium, 1931 Abitur, immediately following thereon: natural science study at the University in Munich. Studies not completed because of army service.
24. French Poor good fair
Serbo-Croat Fair poor fair
English -- poor --
25. 1 April 1932: Entered engineer battalion as Fahnenjunker.
1 October 1932: Transferred to NCO School, Minden/Westfalen.
1 January 1933: Fahnenjunker Officer with Engineer Battalion 7 Munich.
1 May 1933: Infantry School, Dresden, including Fahnrich examination.
1 September 1933. Fahnrich at the Infantry School, Dresden. Attended Course 2 of Infantry School, including officer examination.
1 December 1934. Oberfahnrich.
1 April 1934. Lieutenant in Engineer Battalion, Ulm a.d. Donau.
Zugfuhrer of Company 1.
Commanding Officer of Company 1
Company chief of the staff company, and intelligence officer.
Battalion adjutant.
Chief of 3rd motorized company of Engineers 5.
1 October 1937. 1st Lieutenant
1 October 1939. Captain
During activity with Engineers 5:
Intelligence courses, engineer examinations, courses in organization, tactics, technical subjects, mostly in Berlin.
From 39, selected for general staff duty. During troop duty continuous general staff training with all types of weapons and the most varied tactical command assignments.
1 October 1939.
Commander and trainer of a Landwehr regiment on the Upper Rhine Front.
Later, director of training for battle around fortresses and fortified positions in the Eifel.
10 May 1940 Commander of a motorized advance unit in the 5th Jaeger division in France.
1 July 1940 Training officer for Gibraltar preparations in France.
1 May 1941 Training director in Poland for shock troop fighting in the east steppes.
Company commander - courses for motorized units working with all weapons.
21 June 1941 Commander of a motorized advance engineer unit and battle up to the Moscow area.
4 November 1941 General staff troop training with the most varied types of weapons. Commander of various troop units.

SECRET

SECRET

- 5 April 1942 third general staff officer with the 11th Armored Corps.
1 May 1942 second general staff officer with the 11th Armored Corps.
1 June 1942 War Academy training in Berlin.
1 September 1942 Commander of the 369 Croat Mountain Engineer Battalion No. 1. Major and Regimental commander in the Balkans.
1 January 1943 Commander of a German-Croat fighting group in the Balkans.
1 May 1943 Assigned to duty keeping order and pacifying the population, duties primarily of diplomatic character in Bosnia and Albania-Montenegro.
Autumn 1943 German Commander of the Upper Drina Valley and its adjacent valleys in Bosnia and Montenegro.
15 September 1943 1st General Staff Officer in the Fuehrer's General Headquarters building positions in the east. In connections with this, important intelligence, organization, construction, and supply duties.
After setting up and organizing the unit, ordered to the front.
1 March 1944 Commander of a fighting group with all types of weapons before Kovel.
1 May 1944 Commander of Jaeger Regiment 56 (active Ulm regiment). With this group, outstanding deeds as shock troops ("Feuerwehr") in the Army Group Center in the east.
1 July 1944 Lieutenant Colonel.
1 October 44 Commander of the Peoples Grenadier Brigade 1077.
1 January 1945 Colonel.
12 February 1945 Ninth wound in the east.
From 15 April 1945 With authority from Hitler and Himmler transferred to the 19th Army in southern Germany with special duties for the maintenance of the camps for the German people.
From 2 May 1945 Commander of Karwendel and the upper Isar valley in the projected Alpine fortified holding point.
From 17 May 1945 Gave up my voluntary ties. (Aufloesung meines freiwilligen Verbandes).
Turned myself in as an American POW on 27 May. Arrived at the Neu-Ulm camp, from which was released on 29 June 1945.
Dates do not claim to be unconditionally accurate. Single special training courses and smaller important commands are not included.
26. Today, member of VDK and in the group "Emergency Society of former Members of the Army".
Before Army service: Student Club of my humanistic Gymnasium
Student fraternity, several sport clubs.
27. All kinds of defensive sports (except flying)
Especially: mountain climbing, riding, shooting and skiing in all KFZ types.
Amateur photographer.
28. Free monthly income of DM 1,600 - 6,000. Property value today about DM 75,000.

SECRET

SECRET

29. Until 1931 school, then University, then active Army duty.
From 1945 independent engineer with my own agricultural machinery business
with a small factory.
30. Military specialty articles of passing contemporary interest.
31. My wife, Erna KOPP, with my two children.
My father-in-law Leonhard EISELE
My house maid, Felicitas HEISKE
My business director in Buttenwiesen, engineer Gottfried WINTER.
32. Will SCHLEIF, Oberammargau, (opposite Electric Works).
Willi GEISSERT, Durlach, Bergbahnstr. 1
Werner REICH, Neuwied-Wiederbieber, Schulstr. 7
Otto BUCHHORN, Backnang (Forsthaus)
Helmut STIERLE, Stuttgart, Dresdner Bank
Fritz RACKL, Ulm, Bahnhofstr., Neu Ulm
Max KEMERICH, Mmich (exact address not known)
33. Not applicable
34. 37 years None
37 years None
1.87 cm Upright
blue-gray 91 Kg.
oval White, good
dark Dark blond
male Neck, shoulders, legs
athletic Tall, powerful
35. Wounded 9 times in the east.

SECRET

15
SECRET

MOK-A-22348

Chief of Station, Karlsruhe

8 September 1950

Chief of KOB

General Operational *Mattins* *Gr*
Fnu GENTNER (or KREUTER)

MICROFILMED
MAY 29 1963
DOC. MICRO. SER.

1. In discussions with Walter KOPP, reference MOKA-21761, on the night of 8 September 1950 in the effort to convert KOPP to KIBITZ stay-behind activities, he made the remark that he was aware of similar activities which had been conducted in the East Zone and are now being carried over to the West Zone. He claims to have come upon this information through a person whom he later refused to name, who contacted KOPP in an effort to trace a fnu EMILHEINZ. The person contacting KOPP told KOPP that he should pass the word on so that EMILHEINZ, in some way, might be informed that he should contact Subject, a former CANARIS man, who set up the German stay-behind program at the time of their evacuation from France and who is now doing a similar job in Germany.

2. KOPP's security practices would not permit him to discuss the matter further and we feel no further information is available from source.

- Distribution:
2 - COS
1 - FIM
2 - KOB
1 - POG (American Staff only)

*12 Sept 1950
mke*

INDEX

SECRET
110 COPY

262-255

NAZI WAR CRIMES DISCLOSURE ACT

- EXEMPTIONS Section 3(b)
(2)(A) Privacy
(2)(B) Methods/Sources
(2)(G) Foreign Relations

Declassified and Approved for Release
by the Central Intelligence Agency
Date: 2005

SECRET

MGK-W-6401

Chief of Station, Karlsruhe

3 October 1950

Chief, FIN

Name Checks

REFERENCES: ~~WKA-21760~~

WKA-21760 (Kopp)

1. There is no additional information in our files on any of the persons listed in reference memorandum.
2. Please note that ~~WKA-21760~~ lists as a reference ~~WKA-21760~~. This reference is an error and undoubtedly should read ~~WKA-21760~~.

E J

SECRET

NAZI WAR CRIMES DISCLOSURE ACT

- EXEMPTIONS Section 3(b)
- (2)(A) Privacy
 - (2)(B) Methods/Sources
 - (2)(G) Foreign Relations

Declassified and Approved for Release
 by the Central Intelligence Agency
 Date: 2005

MGB-A-7009.

SECRET

Chief, Karlsruhe Operations Base 7 October 1950
 Chief of Station, Karlsruhe Attn: [] []
 Operational
 Berlin Documents Center Name Checks
 Ref- MKA-21760

You will find attached a report from the Berlin Documents Center
 on persons mentioned in MKA-21760. - Will SCHLEEF, Lt.

[] []

LJF:cvg
Distribution
 2 - KOB (w/6 att.)
 1 - COS
 1 - MCB
 1 - FDM

NAZI WAR CRIMES DISCLOSURE ACT

EXEMPTIONS Section 3(b)

- (2) (A) Privacy
- (2) (B) Methods/Sources
- (2) (G) Foreign Relations

SECRET
IID COPY

~~32-8/4-15 72~~
4-

Declassified and Approved for Release
 by the Central Intelligence Agency
 Date: 2005

VIA: _____
(SPECIFY AIR OR SEA POUCH)

DIS. CH NO. MGK-A- 23/87

SECRET
CLASSIFICATION

TO : Chief, Foreign Division M

DATE: 9 October 1950

FROM : Chief of Station, Karlsruhe *e/mc*

SUBJECT: GENERAL— Operational *...*

SPECIFIC— KIBITZ 15

encl

REF: MGKA-21761

1. We have had two conversations with referenced Subject since our first report (MGKA-21761). The first of these subsequent meetings was in Stuttgart the night of 1 September as scheduled. At this meeting Subject anticipated an answer to his hopes of a US supported German military effort. Our September answer then was that we had written a report of our first discussion with him and that it had been sent forward for consideration at the proper levels, and that the answer might come back through us or just as likely through some other representative of our developments team.

2. Subject was further told that in the meantime we had been given another and more immediate developmental project: that of setting up a stay-behind organization and felt that he would be just the person to work along with us. Remembering his August comments that the German people were not clandestine resistance-minded, we did not dwell on these aspects but rather on the tactical needs for a stay-behind intelligence communications organization which could speed up the Western Powers' way back by communicating troop movement and precise target information, thus incidentally minimizing damage from saturation bombing, etc. As the logic approached his tactical thinking (he is definitely not strategically minded) he was asked to take on as an interim effort the task or test of the feasibility of such an organization. It must be said that his response was less than enthusiastic, that at best he wanted to refer us to men of more experience (who, for example, set up the stay-behind units in France after the German evacuation). In fact, he claimed that he knew of such activities now going on by the same men. We proclaimed our ignorance of any such effort, and that if such were really the case, it must be without US sponsorship and therefore doomed to ineffectiveness due to loose operational securities which would preclude any supporting response from us to unknown or previously unrecognized transmitters. And furthermore, we had been specifically instructed not to contact or try to build on personnel previously associated in such activities. Their previous activities are no doubt known, and thus made suspect, and the personnel have little chance of survival. Thus cautioned, he was told to think it over and write to our post office box for the next meeting.

Dist:
1 - FDM
1 - COS
2 - KOB

A
AN
AT
FI

NO COPY

SECRET
CLASSIFICATION

E J
~~7262-2422~~

FORM NO. 51-28A
MAR. 1949

NAZI WAR CRIMES DISCLOSURE ACT

EXEMPTIONS Section 3(b)

- (2)(A) Privacy
- (2)(B) Methods/Sources
- (2)(G) Foreign Relations

Declassified and Approved for Release
by the Central Intelligence Agency

Date: 2005

3. The next meeting, at his request, was in Augsburg, 29 September. At this meeting his report showed his level of thinking to be quite different from our experience to date. Whereas in such an unreconstructed Reichswehr staff officer, now forced into civilian pursuits, we had hoped to find someone able and happy at the opportunity to set up an organization, parallel to the one we are setting up, which when completed could be directed by him from a position within the retreating Western lines. On the contrary, his map talks and outlines indicate his "cadre" as a "lieutenant to be in charge of completing and controlling the net". He himself wants guarantees that he will always be free to take his place with the first contingent of the West European Armies. Nevertheless, his approach has been sound. He had made a tour of the Zone and, among his trusted old buddies, now responsible businessmen, pretended great anxiety at the present situation in Western Europe with the Western Powers, afraid that taking Germany into the military alliance will precipitate Russian aggression, etc. He reports a heartening response in the manner in which they (as he demonstrated) pounded the tables with "by God, we'll do what we can by ourselves".

4. It must be remembered that in our negative approach of security, we claim ignorance of the machinations of laying on a stay-behind unit. So we anticipate him having to do things the hard way. His problem of radio operators then seems almost insurmountable to him. He discounts former German Army communications men as being subject to neutralization by the occupying powers, or drafted by the Western Powers for active duty. However, he already has a lead to a railroad telegrapher who he feels has promise of stayability (they are in essential employment and "the jobs are too low paid and too undramatic to appeal to the fifth columnists in Western Germany who all hope to be no less than burgomasters or chiefs of police." We of course go along on this, but suggested he not overlook wartime radio operators who are handicapped from wartime wounds and also have stayability. (We fondly hope he has better luck with them than we have had).

5. Subject is presently on vacation and will report to us upon his return to his work of covering the trade in his business of selling farm tractors and excavating machines. This vacation period will purportedly give us time to send in our report of his activities and obtain guidance for his future work. For example, his tactical deployment of his planned agents is at variance to our concepts. However, the question is strictly academic at this early stage of no agents and does not require immediate disposition. Rather, we wish to permit him to work out many of the problems by himself. He is certainly extremely capable and should be able to produce a workable organization. We have not discussed specific terms of compensation or award for his efforts, though we know without his saying it that in addition to the personal reward of voluntary effort well done, he is hoping for a special consideration should Germany be included in the rearmament program. In the meantime, we realize that he is encountering unusual travel expenses as his extra gas consumption required an additional ration of 250 liters for one month. This represents a cost of DM 150.00 for travel alone. We will then work out an operational expense arrangement with him for this trial period of his operation.

SECRET

- 3 -

6. One other item, usually a problem in the development of new personnel, concerns security, or lack of it. In this, Subject presents the issue in contrast and we already see we will have to earn his confidence. Since he, with the German armies, advancing into France found complete files of agent networks, we have had to go to extremes in guarantees that all reports are directly channeled to Washington, and not one scrap of information regarding such sensitive operations as these are kept in Germany. We expect our next contact to be late in October.

for []

000
01 21 1951

RECEIVED
OCT 15 5 08 PM '50

RECEIVED
OCT 10 10 20 AM '50

SECRET

VIA: _____
SPECIFY AIR OR SEA POUCH

DISPATCH NO. MKG-A-23887

SECRET
CLASSIFICATION

TO : Chief, Foreign Division M DATE: 2 November 1950
FROM : Chief of Station, Karlsruhe *(KLG)*
SUBJECT GENERAL. OPERATIONAL
 SPECIFIC. KIBITZ 16
REFERENCE: MKG-A-23888

1. Interest in Subject recruit came in the Spring of 1949 while [] was still living at the Esslingen address of the then KINGDOM II house which was but a short distance down the street from Subject's home address. This was in the earlier KIBITZ stages when we were scratching every German's back in an effort to obtain entree to any and all German social circles in search of likely prospects as yet unviolated by contact with the Amis. Subject then was quite outstanding for his hustling past our house on his way to and from the city in the manner of a man with a purpose and in great contrast to the yet too many postwar Germans who seemed to wander aimlessly through the streets.

2. After the KINGDOM II move to Ludwigsburg we continued occasional street encounters in the vicinity of Subject's Rathaus Platz office where the old nodding acquaintance matured to more amiable exchanges and finally coffee hours, lunches, and evening visits to his home. During this developing period he revealed a background somewhat typical of his class with studies at the universities in Tuebingen, Munich, and Berlin. He was quite active in sports and earned student beer money over and above his allowance by giving ski instructions at the Alpine resorts. In addition, he was quite active in fencing. His participation in the latter sport gives us an insight to the man's character in that the contests as engaged in by students of that era were far different from the refined versions we Americans know. The German technique employed a double-edged sword from the awkward position of the padded sword arm hooked under the chin and around the head from where the sword was wielded in a cutting or chopping motion against the opponent's unprotected face and head. In consequence it was less a matter of the art of attack as it was the fortitude to stand within the squared off area and take it. The winner was declared so by the medical attendant who disqualified the vanquished from further punishment, or by the judge if he detected so much as the slightest flinch in the face of the attack from which there was little room for retreat. Our Subject reports participating in 14 such contests (attested to by some nine scars of 150 stitches in his battered head) of which he lost only one match. That for what was judged as flinching which he denies as being merely a case of sagging under a heavy blow. Nonetheless, he bears the marks of a remarkable man.

DISTRIBUTION
- 2 FDM
1 COS
2 Files

IID COPY
SECRET
CLASSIFICATION

FORM NO. 51-28A
MAR 1949

NAZI WAR CRIMES DISCLOSURE ACT

EXEMPTIONS Section 3(b)
(2)(A) Privacy
(2)(B) Methods/Sources
(2)(G) Foreign Relations

Declassified and Approved for Release
by the Central Intelligence Agency
Date: 2005

SECRET

3. We knew little of his military career except for anecdotes which indicated he started service as an enlisted man and wound up a lieutenant colonel in the Waffen SS, and that he has a partial paralysis of the left hand from a wound for which he was hospitalized in Hungary. However, name checks revealed he was really an ardent supporter of the Fuehrer, Volk und Vaterland, as follows: SA from 19 July 1933 to 30 June 1936; SS (#293565) 1 July 1936; SS Allgemeine 16 Nov 1936; Allgemeine SS Sturmabteilung 1-70 Standarte; Allgemeine SS Sturmabteilung 1-63; Standarte Oberabschnitt South East, rank of Rottenfuehrer; attended SS Junker Schule Braunschweig in 1940; Waffen SS Gebirgs Jaeger Bn Prinz Eugen 42; Waffen SS Infantry Ersatz Bn East 42; Waffen SS Infantry Regt #10/124,2; Waffen SS rank of Hauptsturmfuehrer since 21 June 1944. After the "capitulation" he was incarcerated in Augsburg, Dachau and Ludwigsburg. The period of internment and trial was approximately two years and in the Summer of 1947 he was returned to his wife of 1938 and their two children in Esslingen. In reporting to the local labor office for work he was given further denazification treatment by assignment to one of the details cleaning out cesspools badly neglected since the latter war years. To rub it in, he was assigned to the detail which was working in his own neighborhood. This assignment lasted some 6 months, until the end of 1947.

4. The man whom we noticed in the following year was this humbled but determined lawyer who, after refreshing his law studies by working as a junior member of a downtown firm was now busy building up his private practise to where it is today with an assistant, three stenographers working in relays, and the recent DM 40,000 payment on a DM 100,000 commercial property, the downstairs of which is to be larger office space and the upstairs ten apartments to let.

5. Progress in recruiting was by way of exploratory talks over coffee in which, in addition to his background, he showed a strong pro-Americanism and by and large looked very much like the caliber of man we badly need—someone of military or executive ability who could take a larger responsibility in the KIBITZ activity and who could, for example, in the event of []'s premature departure from Germany, take over certain areas or phases now under development and finish the job.

6. However, when one of the talks of November 1949 dwelled on the possible reaction of West Germans should they be occupied as is East Germany, we were discouraged to hear his opinion that Germans would be unlikely to rise up against such an occupation and those who did would be immediately smothered in the police state. We prudently pulled in our horns at this development but could not reconcile its inconsistency with the man's character and nationalism as attested to by his background. So the contact was continued and as later relations dictated we brought up the matter again. This time we were less abstract, basing our approach on what we considered his conservatism. In the often used tone of asking his opinion or help on matters German strange to an American, he was told that among []'s zone-wide German acquaintances there is starting an organization preparing to resist any possible Communist domination and that [] had been asked to help in organization and, for their security, liaison between the various units. But remembering Subject's opinions of long ago, [] felt they might be doomed without proper restraining

SECRET

leadership and that what they sorely needed were a few stable level-headed men such as he to take some command. Subject needed but a few moments to compose his answer. In fact, he had already given some consideration to what his responsibilities would be under the adversities of a Communist occupation, and that he had decided he did not want to assume a leadership again; he had already had his lesson in that and now felt he could pledge his loyalty for only a minor role.

7. We accepted this as more reasonable than modest, and though it did not measure up to our hopes for a principal personality we do know him to be still a leader among men (now president of the Esslingen Sporting Club) and he certainly could be depended upon to come through in time of need. Thus the matter was permitted to rest in the status of a great potential who could not be pushed but whom we could well allow to find his own level of operation.

8. In the meantime we proceeded with his conditioning by converting our social visits to clandestine meetings in out of the way restaurants, arranged a double-talk code for telephone conversations, etc., and prepared to sit things out while the whole matter jelled. In this we had not long to wait: the legal section of the Land Commissioner's Office asked him to defend three Esslingen Communist Youth members who are to be tried for posting anti-American propaganda posters in and around Esslingen. This unexpected turn created an entire evolution in the planning for Subject in that it might prove an opportunity to ingratiate himself with the communist elements (a few of the party members have already stopped to chat with him, so apparently he is as well acceptable to them as counsel for the youths) and thus enhance his stayability; it almost obviates his acceptance to any other KIRITZ elements.

9. Planning now proceeds in gear with his new status and as outlined to him, he is to set himself up as an independent operator, recruiting his own communications man. For this he offered his brother-in-law, who is a former military radio man and whom Subject describes as a trustworthy "dolt." Arrangements were made for [] to have a look at this brother-in-law ([] was invited over to a family gathering to show his color slide pictures), and the brother-in-law appears possible for the job. In the meantime, Subject had just taken a weekend trip into the mountains to look for a hunting lodge of sorts to purchase as a safe retreat for his family, and probably, as a base for transmitting.

10. Thus, while we can hardly claim credit for planning it that way, we have the makings of a tight little stay-behind unit by a man who seems to know what he is doing and we like the way he goes about doing it.

-3

SECRET

for []
Ann []

[]
~~326-1-2546~~

VIA: _____
SPECIFY AIR OR SEA POUCH

DISPATCH NO. MGK-A-23924

SECRET

CLASSIFICATION

TO : Chief, Foreign Division M DATE: 3 November 1950

FROM : Chief of Station, Karlsruhe *C/M*

SUBJECT: GENERAL OPERATIONAL

SPECIFIC: Recruitment of KIBITZ 17 *Edward WOELLNER*

REFERENCE: MGK-A-23925

Agents
1. Forwarded under referenced memo is Subject's PRQ, Part 1. Subject first came to our attention through [] who is still studying at the University of Heidelberg and does not want to become involved in any intelligence activities except for actual hostilities at which time he expects to be picked up by the Americans (ASA) for his old intercept work. However, he is apparently known among his close friends to have had contact with the Americans so Subject, a fellow student, broached [] with request to be put in touch with the Americans in order to do something in the fight against communism.

2. Subject was a wartime lieutenant under Captain [], who gives his unreserved indorsement of Subject who, he says, is motivated by a capitalism inherited from his father who is a successful manufacturer of soaps and allied chemical products in a firm of 400 employees in a nearby hot spot of communism. Subject realizes that all of the way of life he has known will be lost in the failure to combat communism. While it then seems pretty much the case of a man with a personal axe to grind, it may still be as good a motivation as any. From the information supplied by [] we completed preliminary name checks and had [] arrange for a meeting. The meeting was held in Subject's living quarters in the family (grandmother's estate) home in Heidelberg where Subject lives during the school term.

3. [] left immediately after the introductions and [] was left alone with Subject in a few-hour chat, most of which was of generalities to allow a study of the man. As the first good impressions grew better (he's very alert) he was finally asked what he had in mind as his contribution to the effort. His reply indicated a mind disturbed by the open and aggressive manner of the communist "actives" and he felt that an "alert" organization should be set up to penetrate and liquidate the key "actives" in the first minutes of aggression, thus frustrating the fifth column before it could become effective. However, he claimed no definite plan and would willingly subordinate his wishes to any other activity in which he could be of help. He said his school schedule was not too pressing and he was free to travel because his father had just presented him with the family Mercedes. He

DISTRIBUTION

2 FDM
1 COS
2 Files

FORM NO. 51-28A
MAR 1949

IID COPY

SECRET

CLASSIFICATION

NAZI WAR CRIMES DISCLOSURE ACT

EXEMPTIONS Section 3(b)
(2)(A) Privacy
(2)(B) Methods/Sources
(2)(G) Foreign Relations

Declassified and Approved for Release
by the Central Intelligence Agency
Date: *2005*

SECRET

was told that we knew of no movement in being to which he could be referred, but that [] (as []) job was following up on requests of Germans who feel they have something special to offer the Occupation Forces, and that he would look around for something to suit Subject.

4. Throughout the interview, as security, we avoided dwelling on Subject's known military history in communications and intercept, and somehow we still feel that we might, for the time being, bypass this qualification per se while we consider two other aspects. For one, we have our eyes on the family firm with outlets all over Germany. For this, of course, we would have to recruit the father through the son—probably not too difficult. And on the other hand, such a willing worker, after he proves himself, could become most valuable as a contact to other students, presently concentrated in Heidelberg for easy contact, but with home areas of activity scattered throughout the land.

5. As normal security, especially with people who volunteer their services, we will be careful not to give him any tie-in or information to our already established program. Rather, we will work with him and guide him toward the development of his own initiatives.

Ami
for [] []

SECRET

-2-

~~326-1-2559~~

VIA: KW 3 209
(SPECIFY AIR OR SEA POUCH)

DISPATCH NO. MGK-A-24379

~~SECRET~~
CLASSIFICATION

47428
*1

TO : Chief, Foreign Division M

DATE: 22 November 1950

FROM : Chief of Station, Karlsruhe

CENTRAL INTELLIGENCE AGENCY
CLASSIFICATION

SUBJECT: GENERAL— Operational

SPECIFIC 1 KIBITZ and VULTURE Progress Report

Changed to Secret
BY AD 11/20/50
NAME C
Office EE/19
Date 20 Nov 50

REF: MGKW-6673

KIBITZ Program

1. Submitted herewith is a review of the progress of the KIBITZ Project to date. In this effort to recruit and organize stay-behind agents for the event of hostilities which could cause the European Defense Forces to be pushed back or even out of Europe, we have included the responsibility of getting training to such agents, as well as caching equipment, weapons, and money for their use, but have been able to pay little attention to the development and training of non-commo or accessory personnel to provide intelligence to or support the commo agent.

a. It will be seen that our concentration has been on the development of commo personnel, based on the premise that the establishment of the communications echelon is most essential as an assurance of a communications link through which we could, if necessary, develop other agent activity. Also, experience with the shortage of training personnel has shown the development of commo agents to be our most obvious and critical problem. In fact we have had to re-evaluate our communications candidates and for the time being have about given up further stress on the training of agents from scratch. Except for KIBITZs 6 and 7 who, as University students have rather long vacations which they can spend at MISSOURI, and 2 who owns his own business which he is able to leave for a few weeks at a time during the slack season, we find it almost out of the question to get fully employed or otherwise occupied candidates away (with security cover) to MISSOURI for the several months necessary for training. Even with our present new view of men with previous commo experience who could be brought up to our standards during weekends, we are constantly being frustrated by the inaccessability of the new MISSOURI location in the MOB training area. This creates a travel problem to even our #9 who of all commo candidates lives nearest to MISSOURI and still must spend eight hours of his time from Saturday noon to Sunday evening in the round trip travel. The several months of training for beginners spread out over such weekends is out of the question. As an alternate we have tried in the KIBITZ 3 training project using an instructograph for self study of the basic elementals, such as code, but it is almost impossible to conceal the hundreds of such hours of code practice from other members of a household and the man (see KIBITZ 3) becomes known for his interest in radio.

Dist:
1 - FDM w/atts.
1 - COS w/atts.
2 - KOB w/atts.

CS COPY

CKTS: 1027
COPY No. 1

~~SECRET~~
CLASSIFICATION

FORM NO. 51-28 A
MAR. 1949

NAZI WAR CRIMES DISCLOSURE ACT

- EXEMPTIONS Section 3(b)
- (2)(A) Privacy
- (2)(B) Methods/Sources
- (2)(G) Foreign Relations

Declassified and Approved for Release
by the Central Intelligence Agency
Date: 2005

Solution, of course, would be in a mobilized training program in which the instructors could set up shop in apartments in each of the necessary large cities of Germany where instruction would be practicable in the few hours free time the student could manage away from friends and family. However, Commo is not so endowed with personnel who could be deployed throughout Germany. In the face of this we are attempting to train these part-timers by grooming [] with a little commo experience so that he might be able to provide the experience of temporary training services in hotels convenient to the trainee, where equipment can be provided for them to work by themselves for the few hours they can sneak away from their families. However, [] is really as essentially occupied in searching out burial spots and burying new VULTURE units, replacing old, and adding weapons and emergency funds to other burials. Thus, we cannot look to him for a complete solution to our training problem. It must be hoped that we or Commo will soon see better days with more personnel to devote to training KIBITZ personnel.

b. The phase of developing our non-commo agent personnel strategically placed with special training to cover specific targets has of necessity remained incidental to the general initiative. Though we are thus gradually accumulating men of reasonable agent (as 4, 6x, 10, 11, 13, 15, 16) or accessory (1, 2, 8, 9, 10a, 11a, 14), and cover potential (12, 17, and MGKA-23034) within our own immediate coverage plus the KIBITZ 15 effort, which indicates prospect of some eight or ten more men capable of at least intelligent OB reporting, we have as yet no formulated plans and feel we must wait for Washington guidance in such strategic matters. In this regard we are asking whether Washington would wish to provide us with training material or guides as well as instructions in ciphering which we could now be studying for means of presentation to the agent.

c. Accompanying this report is a map (A) illustrating the deployment of the KIBITZ agents through Germany. The numbers are designations of KIBITZ personnel; numbers 6x, 8x, and 16x represent recruits who are not yet qualified for this report. For ease and clarity we have employed the two colors, red and blue, to distinguish between commo and non-commo personnel. Thus it is seen that of the twenty-three KIBITZ agent personnel, eleven (3, 5, 6, 7, 8x, 9a, 10, 13, 14, 16x, 17) are slated as commo agents and twelve (1, 2, 4, 6x, 8, 9, 10a, 11, 11a, 12, 15, 16) are cast for non-agent or accessory roles. Of the eleven commo agents, two (6 and 10) are trained, and three (3, 9a, and 13) are taking training now. Of the remaining six, 5, 8x, 14, 16x and 17 have had communications backgrounds and could be trained in a very short time, training facilities permitting. KIBITZ 7 has had no commo experience and will require several months training. As a further breakdown, one sees 3, 5, 7, 12, 13, 14, and 17 as lone elements or single agents, and six teams of 2-4, 6-6x, 8-8x, 9-9a, 10-10a, 11-11a, 15 - see para 15, and 16-16x.

The following commentaries on the above agents are each written separately for ease in filing in their individual dossiers.

~~SECRET~~

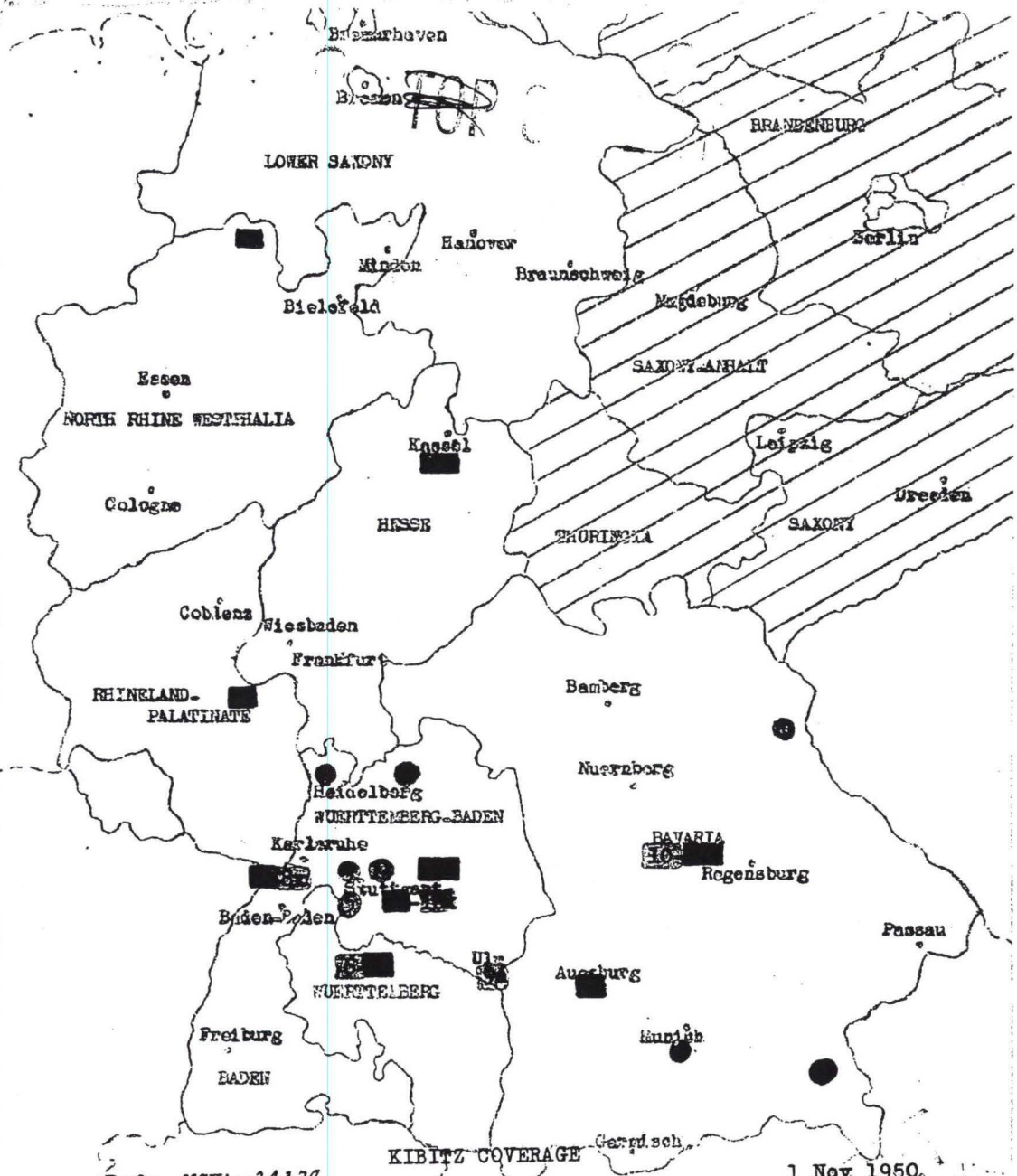

Ref: MGKA-24379
 Legend: Red indicates COMMO Personnel
 Blue indicates non COMMO personnel
 (Circles indicate single elements)
 (Squares indicate team elements)
 (6x, 8x, 16x indicates recruitment in process)
 (For KIBITZ 15, see Map C, MGKA-24379, para 15)

Map A

~~TOP SECRET~~

MGKA-24379

- 3 -

KIBITZ 1

One of our first recruits whose low qualifying code aptitude score did not justify his being sent through our strained training facilities is being held for his potential in some such supporting role as cutout, courier, or informant, depending on his economic, political or social position at the moment of activation. In this regard we tried to guide him into positions which would serve our purpose as well as his, but found that his lack of aggressiveness, which has been for him an asset of unobtrusiveness, is also a liability at the present when we have little time to develop people but must depend upon their own initiative. On the other hand we see no reason to drop him completely, for inasmuch as he would in any event act as only an accessory to other operational personnel, we can well leave him on his standby basis until we have the proper slot for him, at which time he can always be picked up again and be reviewed in terms of his then current value.

Kibitz!

~~TOP SECRET~~
15

KIBITZ 2

a. It is most difficult to predict the future of this case. While it at one time was our most (and only) promising feature of the KIBITZ program, it is now overshadowed by newer developments in other areas of recruitment. However, he still remains the most solid and trusted single element in the whole show. Unfortunately the CARINA [] altered his standing to an as yet undetermined degree and we have had to adjust our thinking accordingly. As far as we know, including mail and telephone intercept, [] has made no further effort to contact KIBITZ 2's family. And while the obvious incentive of the sister has long since been removed for having spent a considerable period of the intervening time with the mother in Switzerland, where she is expected to marry, if [] was not satisfied with BOB's "investigation" of whom [] might have been, [] could certainly have been expected to continue contact with 2 to find out more of what it was all about.

b. However, be that as it may, we have adjusted our sights on 2 and lowered him to a minor role. In the first steps we had disassociated him from 5 and 6. The 5 separation now being most complete since when they moved to a new neighborhood, and both wives since having had new babies, their social visiting came to a complete stop. While 2 was never fully aware of our proximity to 5, the apparent disassociation was further enhanced by casual inquiries of 2 regarding 5's well being and even taking the 5 baby gift to 2 for delivery with the excuse that we just never seem to get time to visit any of the other old friends on our few occasions in Esslingen. On the other hand we use a slight friction between the two wives to implore the 5's never to tell the 2's of our visits with the statement, "You know how jealous she is".

c. As for the 2 - 6 link, as previously stated, they are operationally separated. However, we have learned that there is sometimes more risk in our direct contacts with 6 than through 2 as a cutout. So, in emergencies we still occasionally require 2 to contact 6 for us to arrange meetings. This is done without any explanation to 2 regarding the purpose of the meetings nor are reports in progress made. They each know they are not to learn of details of the other.

d. KIBITZ 2 then stands alone with his 4 and though he has turned up other prospects we have discouraged any expansion without explanation, though we are prepared to tell him, and have even inferred that we do not plan further development in that area but must spread out to other parts of Germany. He of course knows the part he is to play in the stay-behind plans, and should be given Commo training if only up to the basic proficiencies. Then, as later circumstances

Kibitz 2

~~SECRET~~
18

~~TOP SECRET~~

- 5 -

MGKA-24379

dictate, he can be given further training or held in reserve, but he will have had the fundamentals to preface development to his best abilities. As will be discussed under KIBITZ 16, we have formulated an ideal team under a competent chief where 2 could perform as alternate funkier or courier-cutout. In this respect, we are also asking to include 2's wife in the basic training course. Training her for a reserve position does not increase the risk to date but will increase the potential of their element should 2 be drafted into a military or labor unit. She, having seen service in a German Air Force search light battery has a fairly realistic view of what war can be like and would be prepared to accept the pari-military discipline of a stay-behind assignment. Finally, it would be our start (and test) of training women as Commo agents. We repeat, for her as well as him: their training is to be in minimum security basic commo, and would or could be picked up by 16 (who knows them both, but they do not know we are associated with him) would he need or care to use them.

e. VULTURE /B/C or /D could be made available to KIBITZ 2.

~~TOP SECRET~~

~~TOP SECRET~~

- 6 -

MGKA-24379

KIBITZ 3

a. For a long time we had cause to wonder how we would make out with this young fellow. Developed for his qualification of a handicapping paralysis, we at first had no facilities to train him. Later when facilities became available he had become engaged in full employment (Stuttgart Verkehrs Verein) which precluded any extended sessions at MISSOURI as required for beginners. Presented with this almost hopeless situation we did not divulge our real interest in the fellow, and though his finding employment obviated our cover of assessing him for a job with Signal Corps, we continued cultivating him (and his family) on a personal basis while waiting for something to break. However, their response to our interest became embarrassing and actually a burden on them as at least one member of the family was kept on the alert at the window for our visits, and any black Ford in the vicinity was a signal for feverish activity of straightening up the house, spreading a table, and running for wine. At the same time the difference in our ages and lack of common interest caused our relations to become quite pointless. I therefore found "my work in Heidelberg" so pressing that future visiting could be temporarily deferred. However, we had in the meantime switched him from possible employment with the Signal Corps to amateur radio as a hobby for the physically handicapped and he was prepared to receive directions and help toward preparing for this fascinating pastime which might still be useful for work with the Americans at some later date.

b. Therefore, as KIBITZ 14 was recruited we had in mind the need for someone to start #3 in training to get him up to a proficiency where a short session at MISSOURI would suffice. When #14 needed a cover for his time consuming meetings with [] he was told as though it were an honest fact that benevolent American [] had a young paralytic friend who needed a hobby and that [] was willing to help him get started by paying #14 for training him in Morse, helping him build his set, etc. We thus started #3's training under this cover. However, #3, with his psychological handicap which so often accompanies the physical, felt he was an imposition on the obviously busy #14. So, as an alternate we furnished #3 with an instructograph to continue his training alone. [], who is continuing the visits, reports that #3 is making enthusiastic progress. However, living in cramped quarters with the rest of the family has caused #3's training to be a family affair with the one brother participating in the "fun", and the whole family enthusiastically sure that "Mr. Nicholas" will be proud of the boy's achievement.

c. Thus we find ourselves a little wide of our original mark, but will apply controls as possible, such as first hindering #3 from applying for an amateur radio operator's license on the grounds that it had just occurred to us that as a radio amateur he would be booked and catalogued and probably someday be interned should the Communists take over. Therefore he must cease home activity, but if he proves to us that he can keep a secret, we will arrange for him to visit other friends of ours ([] or []) who will let him go

Kibitz 3

~~TOP SECRET~~
15

TOP SECRET

- 7 -

MOKA-24379

on the air with their clandestine sets. Finally, we are sure that when the time comes for him to step into his clandestine role he will do so without the slightest hesitation.

d. VULTURES B/C/D/ or E could be made available to KIBITZ 3.

~~TOP~~ SECRET

~~TOP~~ SECRET

- 8 -

MGKA-24379

KIBITZ 4

Originally recruited for Commo training, we are doing nothing to further develop this man. We have enough difficulties training more desirable Commo men from scratch, and since we have no training facilities for improving on his military experience, which already points him as a military observer and courier-cutout, we feel that further personal contact would be an unwarranted risk. Rather, we will for the time being accept him as he is: KIBITZ 2's selection of a most trustworthy person who can be counted on to do his best under any circumstances be it with #2 or #16.

Kibitz 4

~~TOP~~ SECRET

18

~~TOP SECRET~~

MGKA-24379

- 9 -

KIBITZ 5

a. KIBITZ 5 is a man of considerable communications experience, competent as both radio operator and technician. There is no change in his status, as previously reported nor has he been briefed as to his specific duties, as we feel prematurity is an unnecessary risk. When on occasion he asks, he is told not to worry; one such as he will at the right time be told or find out the right thing to do. As for our present plans, we foresee him as a completely equipped lone communications agent who could at any time be directed to or be picked up by an intelligence agent. Granted that his present employment with the Americans is a deterrent to his stayability, it is one of the compromises we have to make in order to get personnel of Commo experience who are readily convertible to our needs. In this case, as in any other, we will have to hope on false documentation to offset such liabilities.

b. VULTURES B/C/D or E could be made convertible to KIBITZ 5.

Kibitz 5

~~TOP SECRET~~

18

~~TOP SECRET~~

MOGA-24379

- 10 -

KIBITZ 6

a. A test (our first) of training communications personnel from scratch. We are only too aware of his disqualifying factors such as his presidency of the student union, etc. However, it is one of the prices we must sometimes pay in order to get men with enough courage to do the job they are supposed to do. In a country such as Germany, wrought with turmoil and strife through each succeeding generation, we are finding that Germans almost to a man have had more than one opportunity to commit what the Russians might easily consider a crime against a people's democracy, and if they had the courage of conviction which we now need, they are already "guilty" in some manner or other. On the other hand, his mother's social connections in England are innocent enough, as are her connections with France, Italy, Switzerland, Belgium, the Netherlands, etc., any and all countries whose students have studied in Tuebingen and boarded at her home. We feel that she could be only slightly more suspect than any other pension hostess. On the credit side is her pro-Western orientation which prompts her to encourage her last of four sons to give what he can to the cause. As a matter of fact we almost wish we had trained the old lady instead of the son!

b. KIBITZ 6 has had two courses in Commo training, basic and intermediate, taken during his precious school vacations in two sessions at MISSOURI which have left Condon a very much-used instructor. He is yet to have the advanced course on operational type signal plans whenever Commo is prepared to give them.

c. As for operational objective, we foresee him as the communications link to his area of the French Zone for whatever may occur, his own intelligence and guidance tentatively considered to come from his own selected #6x who, as a major on a Corps staff can be presumed qualified to guide this operation. Further efforts to conclude the 6x recruitment are considered premature until we are prepared to offer training in our style of reporting, operational plans, ciphering etc., to better his present potential. This we consider as reasonable in that premature conclusion of recruitment (i.e. contact with []) is an unwarranted risk as well as the fact that previous experience has shown that men of his reported type (attorney) want to see facts and plans. However, we are asking for approval of plans for a field problem in which #6 will recover transmitter, setup and go on the air. (See KIBITZ 10).

d. KIBITZ 6 is, as previously reported, operationally divorced from #2, and neither knows of the other's progress or status. However, we have found it more secure to use #2 as cutout in some cases such as if we require a meeting with #6 in an urgency which could not wait for mail service, (which we do not like to use anyway) and therefore require use of telephone which is not in #6's apartment and therefore risks our American accent being detected by other residents of the house. We can ask #2 to place the necessary cryptic call,

Kibitz 6

~~TOP SECRET~~

16

~~TOP SECRET~~

- 11 -

MGKA-24379

which at least guarantees we will not encounter #6's apartment full of fellow students. (The mother's alertness once saved us from one such disastrous incident.)

- e. VULTURE J could be made available to #6.

~~TOP SECRET~~

11

~~TOP SECRET~~

KIBITZ 7

a. This University of Heidelberg law student remains without change although we had hoped to be able to report him in training at this writing. However, as we were unable to coordinate his part-time MISSOURI training while the school was still in the vicinity of Heidelberg, he now justly enough is resisting our pressure to get him to make the long trips to and from MISSOURI's new secure but isolated location. The first of his sessions for five days of his present eight day vacation was scheduled for 6 November upon his return from a three day visit with his parents. However, he had not yet returned to Heidelberg at our last check on 8 November and though his landlady insisted that it could only be illness of his mother which could delay his return for even another day, we called this session off. The impracticality of making another trip to check on his return so that he could be sent on such a long trip for the remaining short time could have only aggravated the situation. We will wait until his next vacation over the holidays, and try to work things out the best we can until some flexibility or mobility for training can be arranged to accommodate these fully occupied candidates who have to get their training on a part-time basis.

b. The operational employment of KIBITZ 7 will depend upon then current conditions. Until such time as we need give less concern to the communications training phases and can concentrate on the development of agent personnel, #7 is to be considered as a lone Commo agent in preparation to take his place on any intelligence team formed in the Heidelberg area.

c. VULTURE F could be made available to KIBITZ 7.

Kibitz 7

~~TOP SECRET~~

~~TOP SECRET~~

KIBITZ 8

This agent having had no previous Commo experience, is not considered for Commo training, but is to act as recruiter and possibly leader of a stay-behind unit. He has proceeded with such caution that we had about given up on him. However, with no prodding from us his final production of two subagents, one of Commo experience, is indicative of the deep-seated determination to do the job. Negotiations for [] to conclude the recruitment of the two agents are now in progress.

Kibitz 8

~~TOP SECRET~~

~~TOP SECRET~~

- 14 -

MGKA-24379

KIBITZ 9

a. Having had no previous communications experience upon which we could build to develop him as a Commo agent, he has been assigned as recruiter and cutout, 9a (now in training) being his first production. Further, he knows he is to use his communications facilities to report intelligence available to him or to act as link between his Commo agent and any other agent activity as designated for his area.

b. The only significant change in this case is the long hoped for change of employment from the Amerika Haus work to civilian employment. He is now working for the Süddeutsche Zündholz AG, Augsburg. He already completed his probationary employment as production engineer and, as the only obvious replacement for the present over-age staff he stands good prospects of rapid advancement.

c. VULTURE H could be made available to KIBITZ 9.

Kibitz 9

~~TOP SECRET~~

~~TOP SECRET~~

- 15 -

MGKA-24379

KIBITZ 9a

a. A former Wehrmacht funkler who should require only a quickie course at MISSOURI to bring him up to basic proficiency, he is still a training problem to us. Since we missed utilizing his period of unemployment for training, he now thinks we are being a little unreasonable if we try to insist on his travelling eight hours round trip from Saturday noon till Sunday evening to get a few hours in at MISSOURI when he would (or should) rather spend his weekends alternately with his parents and his wife and new baby, or have a good reason why not. However, we did manage to get in some training on the weekend of 28-29 October. He then missed his scheduled meeting for 4-5 November but is spending the weekend of 18-19 November at MISSOURI.

b. He understands that his duties as a Commo agent will be to operate a clandestine radio, probably under the direction of #9, and thus serve as the communications link for intelligence activities, or even, and in a language he better understands, as liaison to resistance groups working behind the Communist aggressor forces lines.

c. VULTURE H could be made available to KIBITZ 9a.

Kibitz 9a

~~TOP SECRET~~

18

~~TOP~~ SECRET

- 16 -

MGKA-24379

KIBITZ 10 - 10a

a. Our Bavarian friend, LEDERHOSEN and all, a converted H'Dienst man, has had two sessions at MISSOURI and requires only the advanced course with operational type signal plans and ciphering when even Commo is authorized to provide such training. As further training for him we are asking for permission to mount a field problem in which KIBITZ 10 will be required to recover a set and actually get off a signal. We feel that such an exercise will be of immeasurable value to the agent and of obvious value to us.

b. Operationally, KIBITZ 10 has a fair knowledge of what will be expected of him and that his duties will be as Commo agent to submit military intelligence information as he is qualified from his military experience to collect and evaluate himself, or to serve as a link to other agents. He has chosen his long time friend, 10a, to assist him and provide protection to his activities. Also, at our request #10 has in full security approached and approved of the subject of MGKA-21834, a life long resident and innkeeper in this upper Bavarian village who can be counted on to provide safe haven to anyone who came in the name of #10.

c. As for #10's past military service as it might influence his stayability, we have spoken to him about it and are working now toward a documentation for him and his family so that he could assume a new identity as auto mechanic, which work he could do very well.

*Kibitz 10
10a*

~~TOP~~ SECRET

18

~~TOP~~ SECRET

- 17 -

MGKA-24379

KIBITZ 11

a. Though of no communications experience, and with little likelihood of training him, KIBITZ 11 was recruited on the basis of his anti-Communist ideals, further qualified through war injuries, for the purpose of building up a stay-behind team in the northern (Kassel) Amzon. To date he has recruited one team member, 11a, but has been hindered from further development due to forced change of employment caused by the business failure of his former employers and he is now employed at EERDECKE in the British Zone. This has caused a dislocation in the #11 - #11a unit. However, he still maintains his family at his old address and we therefore do not consider it a permanent dislocation.

b. VULTURE F could be made available to KIBITZ 11.

Kibitz 11

~~TOP~~ SECRET

18

~~TOP SECRET~~

- 18 -

MGKA-24379

KIBITZ 11a

a. Since his leader, 11, has temporarily moved out of our contact, we have in the meantime established direct contact with 11a, (from information obtained from him and Berlin Document Center - not considered same as Subject of MKK-W-5227) and proceeded with developing his potential as a support for any stay-behind activity in the Kassel area. Inasmuch as neither 11 or 11a is to be trained in Commo, 11a was directed to attempt a cultivation of the few amateur radio operators, one a physician, listed as in a nearby community. Further, we explored his primary asset of being a hunter with hunting rights that give him intimate knowledge of and access to the rural area near his home. From previous discussions he came prepared with a map showing his selection of a drop zone 800 m by 400 m on a plateau of a thickly wooded hill some 3 km from the nearest village. We inspected the area at night and from what we could see, it offered ideal security for drop operations and could even be used as an emergency light plane landing field. Our next step would be to aerial photo strip the area with coordinated bearings (it is an estimated 3 1/4 km southwest from the Fritzlar air base), prepare caches, and if possible dugouts or at least places to hide drop chutes and material until safer disposition could be made. However, any ground work will have to wait until we have personnel to do such jobs, and certainly until spring, as our one trip up there found the road almost impassable and we knocked a hole in our gas tank trying to negotiate the isolated trail. So, as a temporary measure, we later cached the VULTURE set in a nearby but more accessible village. (See KIBITZ 12 for further discussion on development of drop zones).

b. VULTURE K could be made available to KIBITZ 11a.

Kibitz 11a

~~TOP SECRET~~

15

~~TOP SECRET~~

- 19 -

MGKA-24379

KIBITZ 12

a. []'s old one-legged hunting guide is not being considered for Commo training but fulfills a stay-behind operational need by the very nature of his existence as a small farmer with a large leased hunting area. The value of pre-locating such areas is assumed on the premise that we shall be required to make aerial drops of equipment, and such drops would have a percentage of success in direct proportion to our preparations for these drops. By preparation we mean going beyond the primary goal of recruiting someone with such areas under whose control we could survey the terrain. Rather, we view today's accomplishment as little more than an opportunity to go in and pre-develop these areas.

b. First, as part of the survey and for future accurate reference, these areas should be aerial photo-stripped from readily identifiable land marks. Secondly, ground surveys should be made to test avenues of deployment after landing, avenues of apprehension, etc. As we found in the 11a survey, some roads are practically impassable at some times of the year and would have proved disastrous if, for example, it had been planned to travel such roads toward an aerial evacuation. Thirdly, ground developments such as underground bunkers camouflaged to appear as root cellars wherein dropped personnel could take immediate cover to administer first aid, dispose of parachutes, etc., or where dropped material could immediately be disposed of. These elements we take to be essential in defense against alert police who might be attracted by the sounds of a plane making a drop (circling, changes of propellor pitch, the straight run for the drop, gunning of engines after the drop), in which case it would require a pitched battle by a partisan group (which we do not have) in order to defend the drop.

c. We admitted that such a preparation might appear disrelated to recruiting stay-behind agents, and, we are not about to personally undertake such excavation projects. However, it is presented as more than a think piece. It is in our view a necessity to guarantee the success of resupply or replacement of personnel in any stay-behind plans. Such a development will take maximum advantage of the facilities #12 offers. We therefore hope some day for enough personnel to arrange a hunting party billeted at various inns in the vicinity to converge on #12's and 11a's hunting preserve for "wild boar drives" under cover of which such developments can be accomplished.

d. As for #12 himself, though he looks older than his 56 years, one is not to underestimate his agility. The amputation of the left leg at the thigh sometimes seems only an excuse to carry fence vaulting poles made to look like crutches. He is known to be able to keep pace with his wirehaired dachshund on the trail of fox through snow that blocked our car on a secondary road and about exhausted [] and [] just breaking trail the mile or so to his house. Somehow he tagged the word "partisan" to [] definition of our

Kibitz 12

~~TOP SECRET~~

18

~~TOP SECRET~~

TOP SECRET

MGKA-24379

- 20 -

stay-behind project. Called by whatever name he understands, he himself is not slated for an operational activity other than cover or permission to use and develop his land for cover. Nor do we anticipate using any such isolated areas as permanent radio transmission bases, as they would be too easily traced. Of course, VHF beam could advantageously be run from either the #11a or #12 zone elevations.

e. We do not know of nor see danger in his aged wife's knowing of his participation, and once developmental work is done on the farm, she would be equally guilty and moved to guard the security. Also, we see nothing to be gained in contacting the brother in the U.S., as suggested in MGK-W-6673. Incidentally, the brother paid a visit to the old farm this last summer.

~~TOP SECRET~~

18

~~TOP SECRET~~

- 21 -

MGKA-24379

KIBITZ 13

The previous memos fully cover the development of this former Wehrmacht H'Dienst man who offered his service to the American intercept service and who has since been converted to KIBITZ. Really, he converted himself to KIBITZ when he became alarmed at the sudden collapse of Korea. And, when he proposed that the European Defense Forces set up a stay-behind network for the event of a Korean Parallel in Germany, we handled him in the same security as we do all volunteers. That is, we pretended ignorance of such matters, let him sell us on the feasibility of such a project, and then turned him loose to see what he could do. Inasmuch as security forbade us to give him the benefit of advice from our experience, he had to learn the hard way, and when after a few weeks of it we again called on him, we found him spinning his wheels in despair. The experience of enthusiastically presupposing standards of qualification for stay-behind agents, and then trying to find them is like a downhill ski runner hitting wet snow. Thus we found #13 floundering in the face of the discouraging fact that such people are almost non-existent. However, a critique of his work allowed us to think with him and guide him to concentrating on amateur radio operators, starting in Munich. Concentrating on a group of known positive qualifications, he did better; though he unearthed no particular prospects, he felt encouraged. However, his approach was faulty and he was almost sucked into joining a Ham club where, if he made a mistake in recruitments, his person and all his work would be blown or he would be wide open for penetration. A review of this showed his error and led to the more specific area of developing crippled Hams. For this we developed a cover for him as a free lance writer (under false documentation) who is collecting material for a human interest story on Amateur Radio as a pastime for the Physically Handicapped. With this cover he can go directly to any prominent member of the various Ham club chapters and get direct leads to this specially attractive group. Once such contacts are made, they can be developed to our purposes. However, we are not of the nature to bank too heavily on any one such effort. In order to guarantee some results from #13, he is presently being run through MISSOURI to prepare him as an operator in his own right. He has had considerable communications experience, is intelligent, and located in a priority area where we are presently without communication coverage.

Kibitz 13

~~TOP SECRET~~

~~TOP SECRET~~

MGKA-24379

- 22 -

KIBITZ 14

a. Recruited for his technical knowledge of radio, and a leader among amateur radio operators, we had hoped to find his greatest help in bird dogging other amateurs. Help through such a bird dog would normally come by arranging contacts through innocent appearing social activities. However, he is so swamped with work that he has little time for anything else. He has so far offered one recommendation of an amputee radio ham, but rightly enough, does not want to expose himself by making a direct introduction. As yet we have had no occasion to make contact on our own.

b. VULTURE B/C/D/ or E could be made available to KIBITZ 14.

Kibitz 14

~~TOP SECRET~~

KIBITZ 15

a. The suddenness of the crisis in Korea did not only scare KIBITZ 13, it also startled us into thinking that though we too do not believe a general outbreak in hostilities imminent, we take small relief in that our beliefs have not yet been shattered as were probably the beliefs of our counterparts in Korea. However, had such been the case, and we had of necessity evacuated, we would have left a partly finished job with no hope of continuing the work from the outside, nor do we have anyone capable or within our trust with knowledge to be left behind to finish the job. It was in the depth of this despairing thought that KIBITZ 15 appeared with his request to be allowed to do something. And as detailed in previous memos, after sufficient security palavering, we told him of the Defense Forces' need for a stay-behind net. He was offered, and accepted the assignment on a trial basis to see if such a net could be organized and we have worked as closely with him as time would permit. Again we could not present ourselves as a person of any knowledge in the matter but had to permit him to feel that the initiative was all his with only critiques from us through which we guided his activity.

b. This, his first progress report, represents his person to person survey of all likely candidates with whom he had a heart to heart talk regarding their attitudes to the Communist invasion threat. On the basis of these conversations, he divided the candidates into two categories; those who are wholeheartedly and without reservation willing to commit themselves to stay-behind activities for the purpose of gathering and submitting tactical intelligence and act as, or link to, sabotage actives. In the other category, and as evidence of his selectivity, he places those who are now holding out for the western governments to quit their "foolishness" and accept the Germans on their merits as a people who have long recognized and fought the threat of Communism but who are still being viewed as a second class group of people.

c. As the attached map C indicates, KIBITZ 15 has, from his number one group, an organization of 18 agents with 9 communication stations, set up parallel to ours with no lines crossing in any manner. Some of the names have already been checked and we are proceeding with the checking of the others to be sure we are not bumping into any other stay-behind operations. However, we have queried him on each and every man and saw no signs in the responses from them which would indicate their having other tie-ins.

d. Now, though he projects his further activity to cover certain other areas of Germany of strategic importance such as yet uncovered transportation centers and invasion routes, we are asking him to limit further recruiting to only top-notch prospects, to round out his present units and, centered around communications personnel on hand, progressively set up four communications centers. The first step of this is, of course, complete PRQ's on the Commo men to be trained. We hope that by the time the first man is through basic training we will have further word on plans and ciphers so that he as well as we will be able to field operationally readied teams. Thus we would have contact with both shows, come what may.

~~TOP SECRET~~
18

~~TOP SECRET~~

- 24 -

MGKA-24379

KIBITZ 16

a. One of our longest drawn out recruiting jobs, and probably one of our best. As covered in previous memo, #16 is capable of running a worthwhile stay-behind information net. However, his present desire is to work alone with his brother-in-law, a former funkler, as his communications link. And, his part as court appointed defense counsel for three local Communist youth up for trial for activities against the interest of the occupation powers could be considered as a clue to his potential as an agent in good standing with the KPD. However, his proven character and leadership suggest that he can be counted too to chew off a bigger chunk, and for this we wish to prepare other elements for him. We have in mind #2 (and #4) who is in #16's sporting club (#2 does not know of our association with #16), and also #5. With these auxiliaries we could set up a pretty good show in which we would have all the trimming: i.e. #16 as Chief, #16x only receiving (sending on extreme emergency), #2 and/or his wife) and #5, not in contact with each other, alternating in the transmission.

b. VULTURE B/C/D/ or E could be made available to KIBITZ 16.

Kibitz 16

~~TOP SECRET~~
15

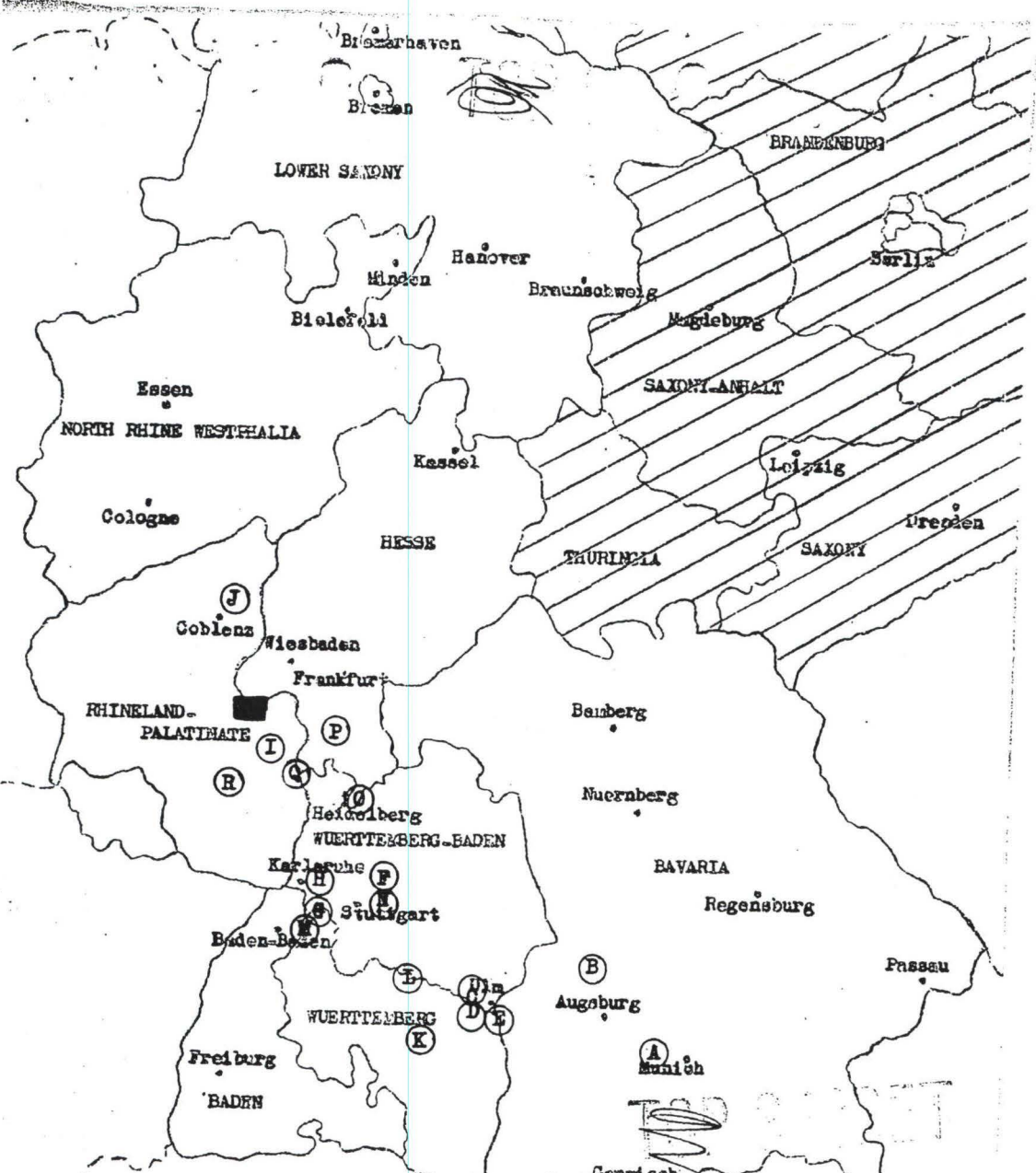

KIBITZ \$15 Staybehind Development
 Legend: Red circles indicate Commo personnel
 Blue circles indicate non Commo personnel

1 Nov 1950

Ref: MGKA-24379

mupc

[]

~~TOP SECRET~~

- 25 -

MGKA-24379

KIBITZ 17

a. Our newest recruit, also a student at the University of Heidelberg, is the son of a successful manufacturer near Mannheim. KIBITZ 17, a former Wehrmacht intercept man under [] had been making bull session talk regarding his concern for the threatening Communist activity about which something should be done, which sounded to [] as though he was ready for recruitment. While [] has no exact details of our activity, he knows we are on the alert for likely persons and occasionally points them out to us. Of these, most are wide enough of our target to indicate [] is not knowing too much, but #17 was a bullseye.

b. As security, we did not tell #17 of what we are doing, but rather asked for his history on which we might be able to formulate an activity for him. He is, of course, a trained Commo man, but beyond that, we see his father's firm which could provide cover employment. Also we are thinking of 17's University contacts which reach to all parts of Germany.

c. VULTURE F could be made available to KIBITZ 17.

Kibitz 17

~~TOP SECRET~~

18

~~TOP SECRET~~ SECRET

MGKA-24379

- 26 -

As we recruit and develop KIBITZ personnel we are ever conscious of the factors of stayability, and where compromises must be made in order to staff men who can be practicably turned out as finished Commo agents we will have to rely on documentation to enhance stayability. This is specifically true of KIBITZ 5, 8x, 9a, 10, 13, 14, 16x and 17, and in a sense, all others in that they too should have documentation which would assist their escape should they find the heat on them. We have therefore initiated the program of preparing documents for all KIBITZ agents, and the fact that TAD's personnel and logistic problems is causing delays of up to six months in getting some of these documents out is, at the moment, not too disturbing. We are sure that when the entire problem of documenting 20, 30, or 50 such people is appreciated, the required personnel can be made available to the project. However, new identities will require more than just documentation to make them stick. In a controlled state, such as Germany is today, and even more stringent in any national crisis, every citizen must be registered and cleared by the police. Every ration and living accomodation request must be substantiated by the police clearance. In most cases, police clearance is obtained from the police of the previous declared residence, which means that anyone expecting to live long under false identity will have had to initiate that identity with an original police clearance from some place and build it up through successive moves to the date of actual need for that identity. Even transients, going from one hotel to another cannot expect to escape for long, because, when the copy of the hotel desk register is sent to the police of declared permanent residence only to be returned with the report that no such person is registered as living there, the new identity is immediately placed on the wanted list and the search is on. Thus every control, including highway and railroad travel, will have to be backed up with a cleared police registration from some originating point through a series of successive moves to the current date.

This, as far as we can ascertain, is best accomplished by cultivating the burgermeister of some place who will trustfully register one as a resident, from where one builds up the identity by moves through other city police channels away from the only possible leak in the security of the process. It is assumed that a minimum of three moves would be sufficient as traces would not likely go back further than that except in extreme cases. But when one thinks of coordinating three such moves for every one of our agents, whether they are to use the identity operationally or as get-away identities, one sees that we have a job cut out for us. Further, we visualize but few of our agents as being mobile enough to take time for each one to cultivate his own burgermeister with a story such as being an East Zone refugee who bought his Kennkarte black and now needs legitimation. We confess that we do not know the answer, but are starting with [] own new identity to see how he makes out and if he is successful, we will go further with the operation. It might be that we will find it necessary to assign a trusted German who would be capable of assuming the necessary identities and, on a full time basis, work the thing through.

~~TOP SECRET~~ SECRET

18



SECRET

MGKA-24379

- 27 -

VULTURE Program

We are also at this time including a summary on the program of caching VULTURE equipment. Though detailed reports of these burials will be found in other memos, we present this VULTURE summary as part of the KIBITZ report in order that the two related projects can be viewed in like perspective.

VULTURE A: Transported piecemeal to Leipzig by [] , it was left in the safe keeping of a wartime buddy, THOMAS, who was instructed to make an interim burial which he did on the site of a ruined hospital. We found it operationally impossible to rebury the set, and since the equipment is now some two years underground, it can be considered deteriorated beyond use and is therefore scratched.

VULTURE B: Buried by [] and [] in February 1949 in an area approximately 6 km north of Esslingen/N (near Stuttgart).
This set could be available to KIBITZ 2, 3, 5, 14 and 16.

VULTURE C: Buried by [] and [] in April of 1949 in Esslingen/N near Stuttgart.
VULTURE C could be available to KIBITZ 2, 3, 5, 14 or 16.

VULTURE D: Buried by [] and [] in April, 1949, in Wuerttemberg/Baden at a point south of the Stuttgart-Munich autobahn where it passes Denkendorf/Stuttgart.
VULTURE D could be made available to KIBITZ 2 who is acquainted with the area.

VULTURE E: Buried in June 1950 by [] and [] in Wuerttemberg/Baden near Stuttgart, Germany.
VULTURE E could be made available to KIBITZ 2, 3, 5, 14 or 16.

VULTURE F: Buried in June, 1950 by [] and [] in Wuerttemberg/Baden between Heidelberg and Bruchsal, Germany.
VULTURE F could be made available to KIBITZ 7 or 17.

VULTURE G: Buried in July 1950 by [] and [] in Hesse near Frankfurt, Germany.

VULTURE H: Buried in August 1950 by [] and [] at the Bavarian border of Wuerttemberg/Baden near Ulm, Germany.
VULTURE H could be made available to KIBITZ 9a.



SECRET
18

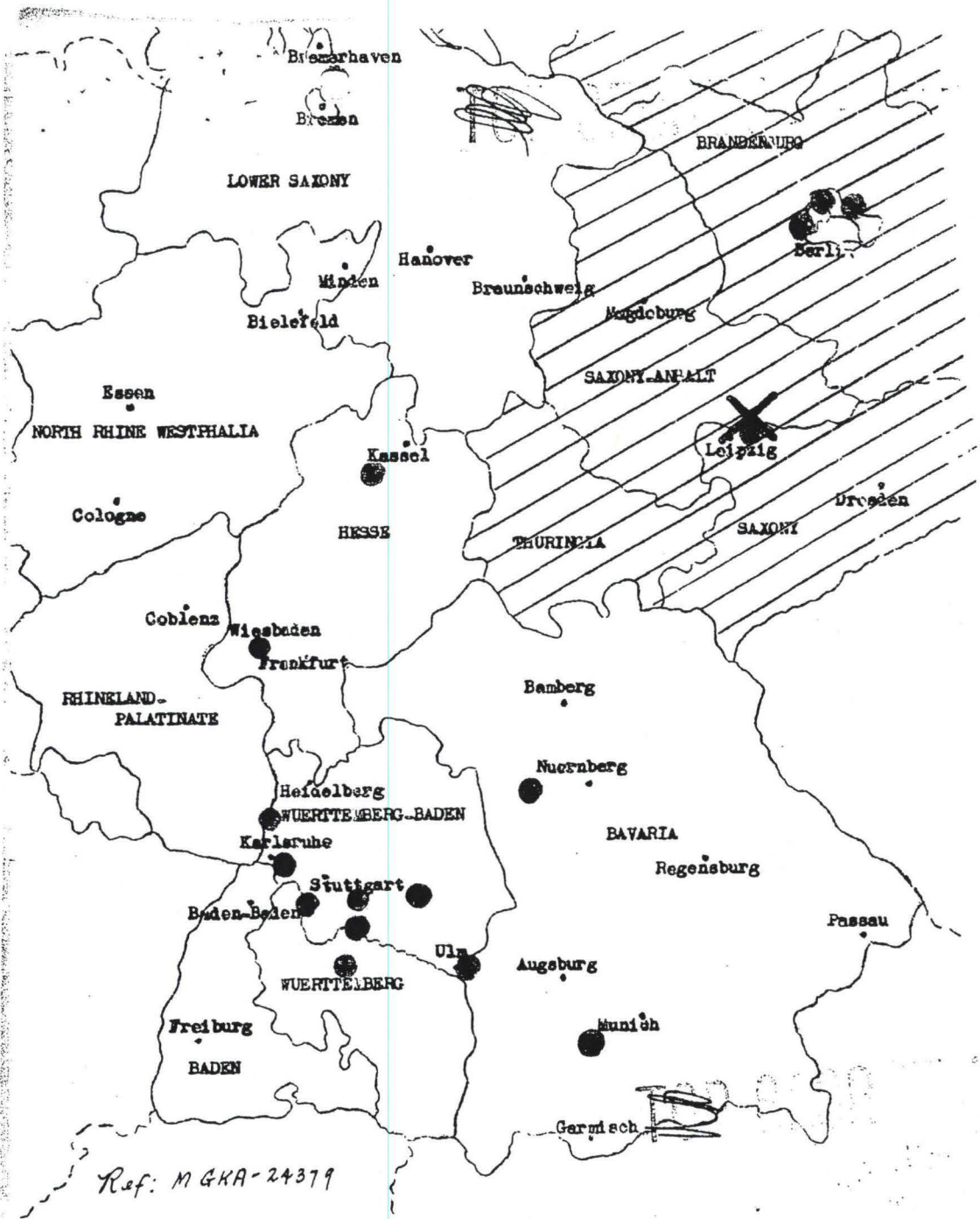

VULTURE BURIAL COVERAGE AS OF 10 NOVEMBER 1950

Map B
 Lap B

VULTURE I: Buried in September 1950 by [] and [] in Wuerttemberg/Baden, Germany at the Frankfurt-Munchen-Etlingen autobahn junction, located approximately 3 kilometers southeast of Karlsruhe.

VULTURE J: Buried in October 1950 by [] and [] in Wuerttemberg/Baden, Germany, (approximately 25 meters from the French Zone of occupation), between Waldenbuch, Kreis Boblingen and Dettenhausen, Kreis Tuebingen.

VULTURE J could be made available to KIBITZ 6.

VULTURE K: Buried in October 1950 by [] and [] in Hesse, Germany, between Ziegenhain and Homberg am Etze.

VULTURE K could be made available to KIBITZ 11 and 11a.

VULTURE L: Buried in October 1950 by [] and [] in Bavaria, Germany, between Ansbach and Schwabische Hall.

VULTURE M: Buried in November 1950 by [] and [] in Bavaria, Germany between Munchen and Landsberg.

[] []



18 ~~3062-3061~~

VIA: (SPECIFY AIR OR SEA POUCH)

DISPATCH NO. MGKA-24398

CLASSIFICATION

TO : Chief, Foreign Division M

DATE: 22 November 1950

FROM : Chief of Station, Karlsruhe *c/kes*

SUBJECT: GENERAL— Operational

SPECIFIC— Identification of KIBITZ 15 Personnel

REF: MGKA-24397

Following is the identification of the personnel listed in reference, together with certain operational information. Because we expect full PRQ's on all of them within the next two months, full name trace requests will be made on these people at that time.

- a. KIBITZ 15a - Communications specialist. Would be 15's commo teacher.
- b. KIBITZ 15b - Has radio operator available.
- c. KIBITZ 15c - Master baker, war wounded, staff officer. Has radio operator available.
- d. KIBITZ 15d - Has radio operator available.
- e. KIBITZ 15e - Student, war wounded, radio operator.
- f. KIBITZ 15f - Considered one of best with good connections and control of other candidates. Has radio operator available. Has probably the best knowledge of west Germany with leads to all classes. Must obtain other employment.
- g. KIBITZ 15g - Subcontractor in construction work. Was radio officer. A good technician.
- h. KIBITZ 15h - Sales and purchasing agent. Former officer. Has good connections with business firms throughout Baden. Could be chief of unit.
- i. KIBITZ 15i - Farmer-hunter (poacher). Has good connections with special lead to communications man.
- j. KIBITZ 15j - Lawyer, Minor court judge. Former officer and good organizer.
- k. KIBITZ 15k - Former staff officer. Good connections.
- l. KIBITZ 15l - Employed as land registrar. Was radio operator but feels he forgot most of it.
- m. KIBITZ 15m - Runs porcelain shop. Was former officer.
- n. KIBITZ 15n - Bank clerk. Was former officer. Now has excellent business connections through bank.

Dist:
1 - FDM
1 - COS
2 - KOB

FORM NO. 51-28A
MAR. 1949

CLASSIFICATION

11D COPY

24-1-3656

NAZI WAR CRIMES DISCLOSURE ACT

- EXEMPTIONS Section 3(b)
- (2)(A) Privacy
 - (2)(B) Methods/Sources
 - (2)(G) Foreign Relations

Declassified and Approved for Release
by the Central Intelligence Agency
Date: 2005

SECRET

- 2 -

- o. -KIBITZ 15o - Construction worker. Was former adjutant for 15 and considered most dependable.
- p. KIBITZ 15p - Former officer. Now practicing general medicine. Was war comrade of 15. Very dependable.
- q. KIBITZ 15q - Stropolizei - former officer.
- r. KIBITZ 15r - Former officer, war comrade of 15.

Anni

Chief of KOB

RECEIVED
15 MAR 2 1945

RECEIVED
15 MAR 2 1945

SECRET

Chief, Foreign Division M
Chief of Station, Karlsruhe
Operational
Identification of Will SCHLEIF, etc.

22 November 1950

REF: MGKA-24398

The following persons are identified in reference memorandum:

- a. Will SCHLEIF
- b. Ruppert REUTER
- c. Otto DAUT
- d. Joseph STRAUB
- e. Walter STEINER
- f. Otto BUCHORN
- g. Karl ROESSLER
- h. Willi GEISSERT
- i. Karl REISS
- j. Werner REICH
- k. Fnu PFITZER
- l. Fnu SCHMIDT
- m. Werner ESTERRIEDT
- n. Helmut STIERLE
- o. Adolph TRUNK
- p. Werner WUERFEL
- q. Harry ADLER
- r. Fnu OBENAUER

Chief of KOB

Digt:
2 - FDM
1 - COS
2 - KOB

mgka-24397

1 COPY

NAZI WAR CRIMES DISCLOSURE ACT

- EXEMPTIONS Section 3(b)
- (2)(A) Privacy
 - (2)(B) Methods/Sources
 - (2)(G) Foreign Relations

Declassified and Approved for Release
by the Central Intelligence Agency
Date: *2005*

SECRET

file
Pastore
MARK 7625

AIR

26 January 1961

Chief of Station, Karlsruhe

ATTN: []

Chief, FDM

Operational

KISITE 15 chain

1. Clarification is requested of apparent inconsistencies which occur in HGL-A-24398 and map "C" attached to HGL-A-24379. On the map KISITE 15b, 15c, 15d, and 15f are listed as communications men, but in HGL-A-24398 they are severally described as "having good leads to a communications man" or as "having radio operator available."

2. It would be appreciated if you could now submit more detailed personal identification of the persons listed in HGL-A-24397 and 24398.

[] [] []

NAZI WAR CRIMES DISCLOSURE ACT

EXEMPTIONS Section 3(b)

- (2)(A) Privacy
- (2)(B) Methods/Sources
- (2)(G) Foreign Relations

SECRET

Declassified and Approved for Release
by the Central Intelligence Agency
Date: *2005*

SECRET

file

AIR

REF-7976

20 February 1951

Chief of Station, Karlsruhe

Chief, FDM attn: []

Operational

EMITE 15

1. The attached statement on EMITE 15 has been prepared by a staff member who was formerly stationed in Germany in a purely military capacity. While the information set forth would certainly be described as derogatory, we do not feel that it is generally inconsonant with the picture of the man already provided by you. In any case, we do not think that it requires any overt action with reference to EMITE 15 himself at this time.

2. In an attempt to clarify EMITE 15's military history and activities, both the apparent inconsistencies noted here and certain questionable features of his own statements, we are asking the Department of the Army for a copy of his "201 file" if it is available. You will be notified of the results of this.

[]

SECRET

NAZI WAR CRIMES DISCLOSURE ACT

EXEMPTIONS Section 3(b)

- (2)(A) Privacy
- (2)(B) Methods/Sources
- (2)(G) Foreign Relations

Declassified and Approved for Release
by the Central Intelligence Agency
Date: 2005

MGKA-A-27022

Chief, Foreign Division M

27 February 1951

Acting Chief of Station, Karlsruhe

Operational

KIBITZ 15 i 1

- KIBITZ 171

REF: MGKA-26331

1. Subject's PRQ was forwarded as an attachment to MGKA-26331. We asked priority processing of his PRQ as we feel him to be the most promising candidate of KIBITZ 15's communication recruits. He is a former radio operator aboard military aircraft who has kept up his proficiency as a civilian radio-electrical technician. He is all the more attractive in that as an independent contractor he will be able to absent himself from family and employment for our communication's training under the cover story of working on an electric installation job contract. We request approval of his training upon receipt of satisfactory tracings.

2. The recruitment of Subject represents KIBITZ 15's first break in getting good, willing and able men with occupation and family responsibilities, who under cover can devote their evenings and weekends for training purposes. We would like to see Subject developed into operational usefulness as soon as possible to give KIBITZ 15 encouragement that he is working in the right direction. KIBITZ 15 has been doing a terrific job but international events, as they affected Germany, have been frustrating his efforts. In this, of course, we can give him full sympathy. On the whole, his efforts and progress are representative of his character and background. Once we can surmount the problems of training (which will be covered in another memo) he should be able to consolidate his teams around trained Commo personnel and be well on the way toward handing over a solid net of qualified agents. Certainly he is already further ahead in his first six months effort, than we were in the first year.

Distribution:

- ~~2~~ - FDM
- 1 - COS
- 1 - KOB

cc. filed Kib. 15 i 1

NAZI WAR CRIMES DISCLOSURE ACT

EXEMPTIONS Section 3(b)

- (2)(A) Privacy
- (2)(B) Methods/Sources
- (2)(G) Foreign Relations

COPY

326-3607

Declassified and Approved for Release
by the Central Intelligence Agency
Date: 2005

SECRET

MJKA-31233

240.1

Chief, TAD

2 August 1951

Chief of Station, Karlsruhe

Documentation

Kennkarte for KIBITZ 15

It is requested that a Kennkarte be made for subject agent based on personalia submitted below.

Name: Karl Walter MUELLER
Geburtsdag: 18 April 1912
Geburtsort: Ortelsburg in Ostpreussen
Staatsangeh: Deutsch
Beruf: Elektroschweisser und Kraftfahrer
Gegenwaertiger
Aufenthalt: Frankfurt/M
Wohnsitz am 1.9.39: Lyck, Ostpreussen
Grosses und Gestalt: 1.86 Kraeftig: schlank
Augenfarbe: blau-grau
Unveraenderliche Kennz.: Keine
Veranderliche Kennz.: Keine
Bemerkungen: Keine

Distribution:

- 2 - TAD w/att. (photo)
- ~~X~~ - COS
- 1 - KOB

NAZI WAR CRIMES DISCLOSURE ACT

EXEMPTIONS Section 3(b)

- (2)(A) Privacy
- (2)(B) Methods/Sources
- (2)(G) Foreign Relations

Declassified and Approved for Release
by the Central Intelligence Agency
Date: 2005

SECRET

SECRET

MGR-A- 31362

Chief, Foreign Division M

2 August 1951

Chief of Station, Karlsruhe

Operational

Subject of MGR-A-31210

240
Kibitz

1. KIBITZ 15 provides the following opinion of subject who is still under assessment.

a. "I have known subject personally for about four weeks though I have heard of his name and his activities since the winter of 1950. He first came to our attention through KIBITZ 15 i who was impressed by this quiet seemingly stable young man. Upon hearing of this man, I encouraged KIBITZ 15 i to develop him further and have been giving regular reports for the past six months.

b. "He is a tall rather slender fellow, otherwise inconspicuous, by his quiet and unassuming nature. According to his friends, he is a good and helpful comrade and an industrious worker whose main concern seems to be fulfilling his responsibilities to his employment and family.

c. "He is a Danzig German and very conscious of it and has the peculiarly East German characteristic of a homesickness for his former homeland. In fact all his aspirations seem to center around the reacquisition of Eastern Germany and it is clear to him that this can only be done by defeating Communism. His espousal of the West is based more on these motives and must be so considered and evaluated. However, his cooperation appears to me to be idealistically valuable and free from purely financial motivations. Contemporarily, he doesn't like the Western Powers as such, resentment against the idiotic post-war politics of the three Western occupying powers is still not dissolved.

d. "Operationally he is of value for his former radio experience in the German Air Force and an aptitude test should determine just how much training he will still need. I am hoping it will be found that with re-training he will not need to have too extensive training as he is urgently needed to work with KIBITZ 15 r in their coverage of a strategically important railway center."

Distribution:

- 2 - FDM
- 1 - COS
- 1 - KOB

NAZI WAR CRIMES DISCLOSURE ACT

SECRET

EXEMPTIONS Section 3(b)

- (2)(A) Privacy
- (2)(B) Methods/Sources
- (2)(G) Foreign Relations

Declassified and Approved for Release by the Central Intelligence Agency

Date: 2005

VIA: _____
(SPECIFY AIR OR SEA POUCH)

DISPATCH NO. MGK-A-31712

SECRET
CLASSIFICATION

TO : Chief, Foreign Division M

DATE: 13 August 1951

FROM : Chief of Station, Karlsruhe *CHK*

SUBJECT: GENERAL—Operational

○ SPECIFIC—Salary - KIBITZ 15

REF: MGK-A-31211

1. In paragraph 2e of reference we stated that a lump sum of DM 10,800 was needed for KIBITZ 15 expenses and salary for the remainder of calendar year 1951, further that MGK-A-31158 would contain the specific request. MGK-A-31158 has been canceled and will not be sent. This memorandum replaces it.

2. Within the next few days [] will propose a salary of DM 900 per month to KIBITZ 15. We feel that this is not excessive for this valuable agent who has worked one year for nothing and is now spending 90% of his time on work for us. In three months we anticipate raising the monthly total to DM 1000. []'s progress report on this activity follows in MGK-A-31713.

3. Subject will continue to be paid DM 20 per day per diem while traveling and DM .185 per kilometer for use of his own automobile.

Distribution:

- ~~2 - FDM~~
- 1 - COS
- 3 - KCB

AN	<input checked="" type="checkbox"/>
AB	<input checked="" type="checkbox"/>
IN	<input type="checkbox"/>
PS	<input type="checkbox"/>
FX	<input type="checkbox"/>
RECORDS	<input type="checkbox"/>
FI	<input type="checkbox"/>

IR COPY

206/5020

SECRET
CLASSIFICATION

FORM NO. 51-28A
MAR. 1949

NAZI WAR CRIMES DISCLOSURE ACT

EXEMPTIONS Section 3(b)

- (2)(A) Privacy
- (2)(B) Methods/Sources
- (2)(G) Foreign Relations

Declassified and Approved for Release
by the Central Intelligence Agency

Date: 2005

VIA: Pouch K-1-2947
(SPECIFY AIR OR SEA POUCH)

DISPATCH NO. MGK-A-31713

89573
#1

~~TOP SECRET~~
CLASSIFICATION

TO : Chief, Foreign Division M
Attn:
FROM : Chief of Station, Karlsruhe C

DATE: 17 September 1951

SUBJECT: GENERAL— Operational
 O SPECIFIC— KIBITZ 15 - Progress Report

CENTRAL INTELLIGENCE AGENCY
CLASSIFIED IN
~~SECRET~~
Secret
BY ON
Date 20 SEP 1951
ISL

REFS: MGK-A-31712, 21761, 32196

1. It will be remembered that Subject is the former German Army colonel who wrote to Mr. McCloy and was subsequently referred to us. After satisfactory security checks and interviews to set things up, he was offered an opportunity to prove his sincerity and ability by pioneering in setting up a stay-behind agent organization in Germany.

2. His recruitment at that time was most opportune in that this case officer was already considerably over-extended in our stay-behind project and further progress would depend on additional personnel. Further, experience was revealing the security risks involved in our many personal contacts required during the overt stages of development. And, even after the recruits are converted to clandestine meetings we still have the disproportional risk of American-German meetings required to hold the interest of the stay-behind agents who, while waiting for training or other tangibilities in confirmation of their mission are continually subjected to bad press and deteriorating opinion of the occupation forces. Therefore we were ready for a German of proper outlook and stature who could be employed in furthering the stay-behind project. This unreconstructed Reichswehr professional seemed just the man and his progress to date has proved our estimate.

3. He has, in the past eleven months developed a stay-behind agent organization parallel to and without knowledge of our basic net. This type of effort in winning and controlling personalities does not provide ready measures of production. Working with him on his project, while at the same time having our counterpart work at the same level to use as a yardstick to his efforts, has brought us to recognize his progress as faster and further than ours. Further, his progress is much to his personal due and not to be credited just to his facility of being a German among Germans. We have always had to be extremely discreet in our guidance so as not to tip the pitch of our own net, and thus have had to permit him to do things the hard way with errors in planning and practice for which he had to learn the answers for himself. But we seldom had long to fret until he again found the right track as the accompanying organizational chart will indicate.

AN	<u>6</u>
AB	<u>X</u>
IN	<u> </u>
PS	<u> </u>
EX	<u> </u>
DE-INT	<u> </u>
FI	<u> </u>

Dist:
2 - FDM w/att.
1 - SFRG w/att.
1 - COS w/att.
1 - KOB w/att.

CS COPY

~~TOP SECRET~~
CLASSIFICATION

GKTS-1220
COPY No. 1

32 64-54678

NAZI WAR CRIMES DISCLOSURE ACT

- EXEMPTIONS Section 3(b)
(2)(A) Privacy
(2)(B) Methods/Sources
(2)(G) Foreign Relations

Declassified and Approved for Release
by the Central Intelligence Agency
Date: 2005

~~TOP~~ SECRET

- 2 -

4. For reading this new chart we refer you to MGK-A-32195 and MGK-A-32196 in which we identify the new codings we have had to switch to in replacing the former system of combinations of letters of the alphabet and numbers (such as 15 i 2 or 15 f 3) which were to indicate leadership or subordination within the teams but which became unwieldy and meaningless as we reassigned personnel to suit changing assessments and manpower needs. As a further guide to the chart, we call your attention to the legends: Blue circled numbers indicate non-Commo personnel; red circled numbers indicate Commo personnel, (shading within the circle indicates degree of training, i.e., readiness); green circles indicate personnel under development.

5. From this chart then, (extracted from MGK-A-32195), we see his 45 agents lining up into what could be 14 teams. But, as mentioned, we are making consolidations to bring up the manpower in each team and we expect the KIBITZ 15 complex to wind up with about 12 complete teams, which is about all one man can properly handle. Unfortunately, this organizational chart is about all we can present at this time to show his progress. However, we are finding his best production coming out of his knowledge of the country and his background in military strategy and tactics which he is pulling together into operational briefs for his teams. In fact, his first drafts of this work already so surpass anything we could hope to do ourselves that the student has become the teacher. Unfortunately we are handicapped for want of a translator for this project and so are as yet unable to present this work, now running into volumes, for critique and approval.

Handwritten notes:
Send
to
the
CIA
for
approval
M.L.

6. Until most recently KIBITZ 15's work has been an outgrowth of what started as a trial period without salary or promises. But guessing his way of thinking, he no doubt can see his place as a key agent after evacuation from where he will direct the activities of the net he is now spinning. We fully recommend Washington's acceptance of this possibility. Who would better know the capabilities of these men left behind, and thus direct their missions and brief their replacements? Who could better guard against penetrations, defectors or playbacks? Obviously he can remain a valuable asset. In any event, now as we approach the anniversary of his working for us, we thought it right to offer him some security or permanency in his agent status. Our budget estimate in MGK-A-31211 included sufficient funds to offer him a salary of DM 1,000 per month, and as related in MGK-A-31712, we began paying him DM 900 monthly as of 1 August 1951. Though we find that this is a modest sum for an agent doing his caliber of work, and less than some such others in paramilitary duties, he nevertheless accepted our offer as a long sought basis upon which to make a businesslike arrangement for a manager of the farm tractor business (which he never was too enthusiastic about) and which he has preferred to neglect while spending more and more time on stay-behind work. We estimate that he will be spending about 90% of his time for us, the remaining 10% to be in keeping up old business contacts as cover for his activities. Surprisingly though, he seems to consider this step from an avocation of intelligence work to that of a vocation as a rather serious matter, and he expects it will be accompanied with a contract, job specifications, etc. We are taking the matter in advisement and if possible,

~~TOP~~ SECRET

~~TOP~~ SECRET

- 3 -

will prepare an employment agreement to satisfy his mentality but in no way binding in our obligations. In this respect we are aware of the one-sided nature of the sample contracts described in GAI 11/6.

[I dip
gmt

~~TOP~~ SECRET []

~~TOP SECRET~~

32-6-1-54674

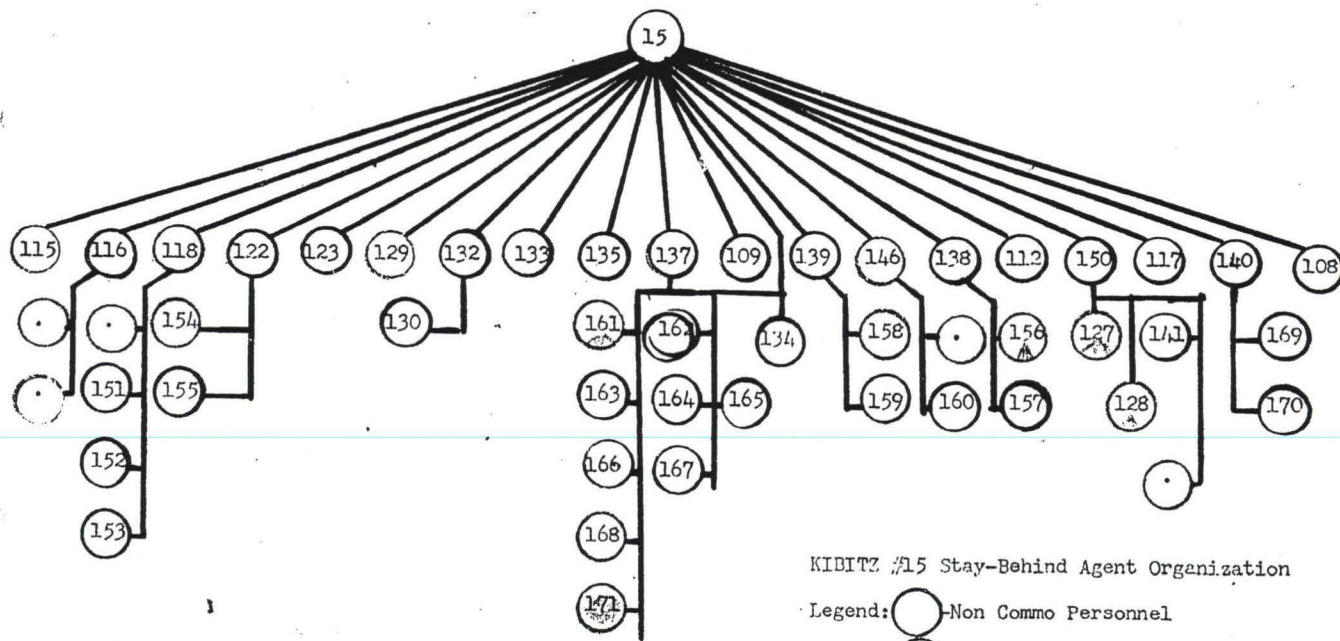

CS COPY

KIBITZ #15 Stay-Behind Agent Organization

- Legend:
- Non Commo Personnel
 - ◐ Commo Personnel (shading indicates degree of training)
 - Personnel under development

NW 0011 MGKWA 31713

~~TOP SECRET~~

23 August 1951

~~TOP SECRET~~ SECRET

Attachment to MKK-A-32195

<u>ITEM</u>	<u>NEW</u>	<u>OLD</u>	<u>REMARKS</u>
1.	101	none	under development
2.	102	none	under development
3.	103	none	under development
4.	104	none	under development
5.	105	none	under development
6.	106	none	under development
7.	107	none	under development
8.	108	none	
9.	109	none	
10.	110	none	under development
11.	111	none	under development
12.	112	none	
13.	113	none	under development
14.	114	none	under development
15.	115	none	
16.	116	15-a	
17.	117	none	
18.	118	none	
19.	119	none	under development
20.	120	none	under development
21.	121	none	under development
22.	122	15-c	
23.	123	none	
24.	124	none	under development
25.	125	15-k	under development
26.	126	15-l	under development
27.	127	15-f-1	
28.	128	none	
29.	129	15-g	
30.	130	none	
31.	131	15-m	under development
32.	132	15-h	
33.	133	15-o	
34.	134	15-q	
35.	135	15-j	
36.	136	none	under development
37.	137	15-i	
38.	138	15-r	
39.	139	none	
40.	140	none	
41.	141	none	
42.	142	none	under development
43.	143	none	under development
44.	144	none	under development
45.	145	none	under development
46.	146	none	
47.	147	none	under development
48.	148	none	under development
49.	149	none	under development
50.	150	15-f	

~~TOP SECRET~~ SECRET

1464527
Encl. 1

~~TOP SECRET~~

- 2 -

<u>ITEM</u>	<u>NEW</u>	<u>OLD</u>	<u>REMARKS</u>
51	151	15-b	
52	152	none	
53	153	none	
54	154	none	
55	155	15-d	
56	156	none	
57	157	none	
58	158	none	
59	159	none	
60	160	none	
61	161	15-1-2	
62	162	none	
63	163	none	
64	164	none	
65	165	none	
66	166	none	
67	167	none	
68	168	none	
69	169	none	
70	170	none	
71	171	15-1-1	

CENTRAL INTELLIGENCE AGENCY
CLASSIFICATION
Changed to Secret
BY AU [Signature]
Name [Signature]
Office EEI/9
Date 20 JAN 1950

~~SECRET~~

6774
[Signature]

SECRET

KOB

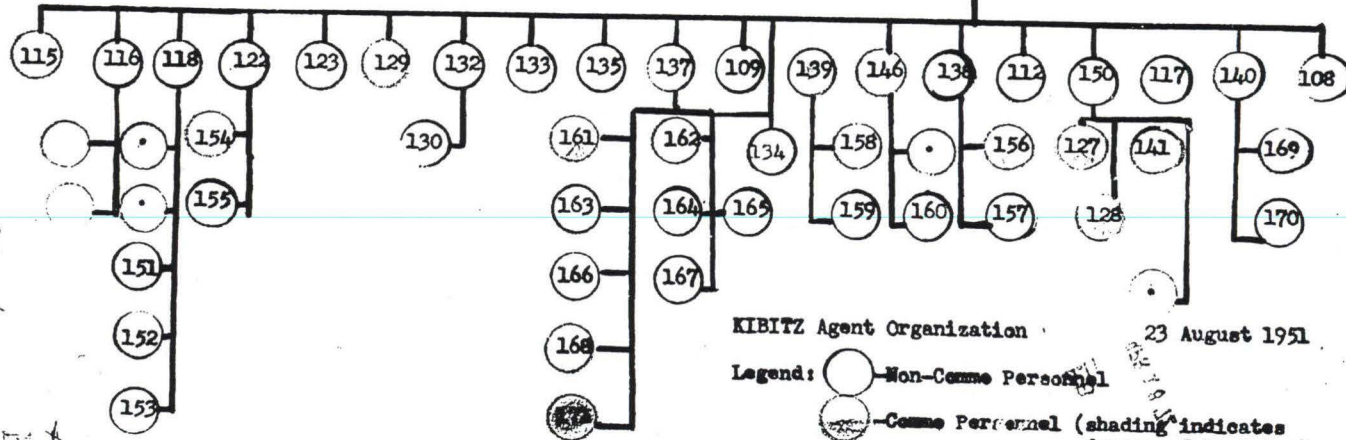
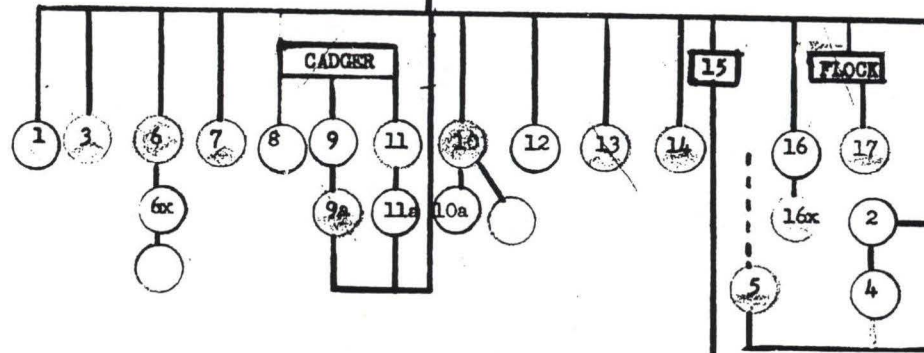

KIBITZ Agent Organization 23 August 1951
 Legend: ○ Non-Comm Personnel
 ◐ Comm Personnel (shading indicates degree of training)
 ○ Personnel under development

32-6-1-54699 (KOB)

SECRET

VTA* (SPECIFY AIR OR SEA POUCH)

*94 KW-2946
KARLSRUHE*

*67590
#1*

DISPATCH NO. MGK-A-32196

SECRET
CLASSIFICATION

TO : Chief, Foreign Division M

DATE: 17 September 1951

FROM : Chief of Station, Karlsruhe *CHATT*

SUBJECT: GENERAL - Operational

SPECIFIC - Identifications

The following is a list of names keyed to the attachment to MGK-A-32195:

ITEM NAME AND ADDRESS

- 1.
- 2.
- 3.
- 4.
- 5.
- 6.
- 7.
- 8.
- 9.
- 10.
- 11.
- 12.
- 13.
- 14.
- 15.
- 16.
- 17.
- 18.
- 19.
- 20.
- 21.
- 22.
- 23.
- 24.
- 25.
- 26.
- 27.
- 28.
- 29.
- 30.
- 31.
- 32.
- 33.
- 34.

CENTRAL INTELLIGENCE AGENCY
CLASSIFICATION
Secret
BY AUTHORITY OF
NAME *68/AV*
OFFICE *20 JAN TSC*
DATE

Paul GABLER, Munich, Archivstrasse 13 (Formerly, Jagdstr. 5)
Family SISSMATER, Munich/Pasing, Paul-Gerhard Allee

Dr. W. LINKE (veterinarian), Bayreuth
H. GEHRINGER, master welder, Staffeldain/Bamberg
Herbert LAMBRECHT, wood croaker, Garmisch/Partenkirchen
 Helmut SCHADE, Children's Home, Oberammergau
 Wilhelm SCHLEIF, Insurance inspector, Steingaden/Dachau, Freisingerstr.
 Dr. Toni EISELE, Augsburg/Oberhausen, Donauwoerthstrasse
 Dr. Fred NUSSER, Mertingen Ueber Donauwoerth

Karl Heinrich FRICKE, Northaim; Seesenerlandstrasse 11a
 Otto DAUT, Hafenbad, Ulm/Donau
 Friedrich LINDSTEDT, Ulm/Soflingen, Bei den Quellen #11
 Alfred WOERZ, Ravensburg, Marienplatz 2

Wilhelm SCHAIBLE, Stuttgart/Vaihingen, Parkstrasse 14/II
 Hans HARTUNGEN, Backnang Fabrifstrasse 11
 Karl ROESSLER, Muehlacker, Hindenburgstrasse 112
 Friederich Wilhelm GEISSERT, Freiberg/Ihringen

Willi GEISSERT, Karlsruhe/Durlach, Bergbahnstrasse #1
 Adolph TRUNK, Heidelberg/Maich, Bahnhofstrasse
 Harry ADLER, Gernsheim/Rhein

AN	AB
IF	YS
EX	DES
FI	HFD

CS COPY

17 SEPS

Dist: EDM 1 - COS
1 - SRFG 1 - KOB

SECRET
CLASSIFICATION

GKTS-1222
COPY No. 1

FORM NO. 51-28A
MAR. 1949

NAZI WAR CRIMES DISCLOSURE ACT

- EXEMPTIONS Section 3(b)
- (2)(A) Privacy
 - (2)(B) Methods/Sources
 - (2)(G) Foreign Relations

Declassified and Approved for Release
by the Central Intelligence Agency
Date: *2005*

SECRET

- 2 -

<u>ITEM</u>	<u>NAME AND ADDRESS</u>
35.	Dr. Werner REICH, Neuwied/Niederbieber
36.	
37.	Karl REISS, Gauersheim
38.	Otto OBENAUER, Marnheim-Monsheim (R.R. master)
39.	"Mucki" MOKOWSKY, auto salesman, Dunkel-am-Fackel Rondel, Kaiserslautern
40.	Insurance inspector DIEHL, Kaiserslautern, Am Stiftplatz
41.	(Nurse) MONIKA, Children's Home, Bad Toelz, Mail Address: Munich, Brienerstr. 55
42.	
43.	
44.	
45.	
46.	Helmut BURKHARDT, Obermoschel (Keiper Elevator Mfg.)
47.	<i>Eugen FRANZ, Gauersheim</i>
48.	<i>Karl BLOMEYER, Gauersheim</i>
49.	<i>Friedrich DINGER, Gruentadt/Pfalz</i>
50.	Otto BUCHHORN, Backnang-Oppenweiler
51.	Ruppert REUTNER, Unterthuerheim
52.	Franz REUTNER, Unterthuerheim
53.	Fred NUSSER, (student son of 118) Mertingen/Munich
54.	Friederich MACK, Ulm/Donau, Bockgasse
55.	Joseph STRAUB, Ulm/Donau, An Der Blau
56.	Alfred GOERTZ, Albisheim, Alleestr. #1
57.	BERGMANN (farmer), Albisheim
58.	A. Ring, Kaiserslautern, Schuberstrasse 33.
59.	Aquilin CHRISTMANN (insurance inspector), Kaiserslautern, Am Waldschloeschen
60.	Dr. Heinz RAPP, Ebernburg
61.	Hans MIETHIG, Gauersheim
62.	Herbert HOELGERT, Ilbesheim
63.	Otto HILDEBRAND, Gauersheim and Rheinfahre Worms
64.	Herman FUCHS, Freimersheim and Worms
65.	Fritz PFOERTNER, Proembeler Radio Sales, Alzey
66.	Werner Klippelberg, druggist, Kirshheimbolanden
67.	(master baker) Ansbach, Eisenberg
68.	Otto KEIM, Alzey
69.	(farm machinery salesman) WILD, Kaiserslautern, am Nordbahnhof
70.	Walter ERBACH, auto sales, Kaiserslautern, Mainzerstrasse
71.	Horst IMS, Kirshheimbolanden

58

[]
SMK

SECRET

E]
32-6-1546794

SECRET

MEMORANDUM

For: Files
From: []
Subject: Walter Kopp

copy 15
20 SEP 51
(1947)
MSGW-7976

1. In June and July 1945 I was stationed in Buttenwiesen bei Wertingen, not far from the residence of Walter Kopp. I had seen his wife several times on the street and one day in July 1945 she approached me with the request that I send a letter to her sister in Switzerland, explaining that the latter was probably worried about her relatives in Germany. I consented to do this, but checked the contents of the letter before mailing it. The letter was addressed to FrL. Hilda Eisele, Villa La Rondine, Lugano-Castagnola, Switzerland. Inside the cover envelope was another containing a letter written by Walter Kopp, addressed to another person in Switzerland, whose name, as I recall, was Dutch.

2. This letter was in no sense a personal one, but rather a four page political diatribe, lamenting the defeat of Germany and condemning the Allies. Two items I remember were: 1) That the Americans were responsible for the inflation in Germany, since they had issued occupation currency; and 2) That the Allies had no right to accuse Germany of violating the Geneva Convention, considering the manner in which Germany was being treated. The person who gave me a summary translation of the letter remarked that although he, too, had been a good Nazi, he was at least willing to see what the Americans had to offer, which was apparently more than Kopp was willing to do.

3. I made no effort to send this letter to Switzerland, but returned it personally to Kopp about a week later, explaining to him that I wouldn't send a letter of this kind. Kopp rather indignantly demanded to know what was wrong with the letter. This was the only time I spoke to the man, although I have seen him several times.

4. I next heard news of Kopp in February 1949. I received a letter from Mr. Georg Kirner, a resident of Buttenwiesen bei Wertingen. Kirner is the proprietor of a successful general store in Buttenwiesen, a member of the town council, and a delegate (CSU) to the Landkreistag. In 1945 he was appointed assistant Burgermeister of Buttenwiesen by the Military Government. I have known him since this time as a widely-respected person in the community. Kirner stated that he had been attacked and brutally beaten by Kopp and two of his friends from out-of-town, both former Colonels. As a result Kirner suffered serious injuries and had been bed-ridden 10 days.

NAZI WAR CRIMES DISCLOSURE ACT

EXEMPTIONS Section 3(b)

- (2)(A) Privacy
- (2)(B) Methods/Sources
- (2)(G) Foreign Relations

SECRET

Declassified and Approved for Release
by the Central Intelligence Agency
Date: 2005

SECRET

5. Kirner subsequently brought suit against Kopp and the two former Colonels. I later read his affidavit to the court concerning the incident, a summary of which is approximately as follows: Kirner and his daughter were sitting in the inn in Pfaffenhofen, the village adjoining Buttenwiesen. They were invited to join another table where Kopp, his wife, the two former Colonels, and possibly others were seated. This Kirner and his daughter did, but left the table when this group, headed by Kopp, began to sing obscene songs (some rather startling extracts from which were cited in the affidavit). Kirner was asked by a member of Kopp's party why he had left the table, to which he replied that gentlemen didn't conduct themselves in such a manner, or in words to that effect. Shortly thereafter Kirner was told that someone wished to speak with him outside. Kirner left the inn and upon entering the front courtyard was seized and brutally beaten by Kopp and the two former Colonels for a period of several minutes. Passers-by broke up the fight, and according to Kirner, it was only at his insistence that other persons in the inn did not attack Kopp and his two confederates. Incidentally, Kirner's affidavit refers to Kopp as a former Oberleutnant. This is inconsistent with Kopp's PRQ, wherein he states that he was made a Colonel on 1 Jan 1945.

6. Kirner informed me that he had been notified by Kopp's attorney that the latter's client was willing to discuss payment of Kirner's medical expenses (about 250 DM), as well as compensation for the time spent in bed, but that Kopp balked at the demand that he print a letter of apology in the newspaper. I have no further knowledge of later developments in this lawsuit.

7. In April or May 1949 Kirner informed me that he had heard from a friend in the tax office in Wertingen that Kopp was in serious financial trouble and had been compelled to sell his car. Kirner believes that the farm machinery agency and adjoining property belongs to Kopp's wife.

8. Regarding Kopp's movements at the end of the war, one of Kirner's sons told me that Kopp arrived in Pfaffenhofen around the middle of April 1945, and that he remained there until the Americans came--on 26 April. As further evidence he cites Kopp's appearance in full uniform in front of the former synagogue in Buttenwiesen, used as a storage depot, where some villagers were helping themselves to Wehrmacht clothing supplies. Kopp waved his pistol and threatened anyone who molested Wehrmacht property. This incident occurred a few days before Americans entered the area. This testimony is, of course, inconsistent with Kopp's statement in his PRQ, that on 15 April 1945 "with authority from Hitler and Himmler" he was transferred to the 19th Army in Southern Germany, and that on 2 May 1945 he was commander of Karwendel and the upper Isar valley.

9. The Catholic priest in Pfaffenhofen, a neighbor of Kopp, told me in the summer of 1949 that he considered Kopp an embittered Nazi-militarist who has not been very successful in his civilian pursuits.

SECRET

~~SECRET~~ SECRET

1974
#2
MGK-A- 33077

Chief, Foreign Division M
Attn: []
Chief of Station, Karlsruhe

27 September 1951

Operational

Attachment to KIBITZ Progress Report

We regret that inadvertently the third sheet to the attachment to MGK-A-32195 was not attached. It is enclosed herewith.

Distribution:
[] FDM w/att.
1 - SRFG w/att.
1 - COS w/att.
1 - KOB w/att.

filed with MGKA-32195.

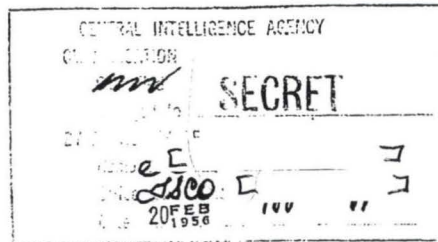

NAZI WAR CRIMES DISCLOSURE ACT
EXEMPTIONS Section 3(b)

- (2)(A) Privacy
- (2)(B) Methods/Sources
- (2)(G) Foreign Relations

~~SECRET~~ SECRET

GKTS- 1229
COPY No. 2

Declassified and Approved for Release
by the Central Intelligence Agency
Date: 2005

MEMORANDUM

17 October 1951

TO : STC/OCO
FROM : FDM/Germany
SUBJECT: Change of Cryptonyms

For your information, the following cryptonyms in the KIBITZ Project have been changed as indicated:

<u>Old</u>	<u>New</u>
KIBITZ 15 1 1	KIBITZ 171
KIBITZ 15 1 2	KIBITZ 161

NAZI WAR CRIMES DISCLOSURE ACT

EXEMPTIONS Section 3(b)

- (2)(A) Privacy
(2)(B) Methods/Sources
(2)(G) Foreign Relations

Declassified and Approved for Release
by the Central Intelligence Agency
Date: 2005

SECURITY INFORMATION

VIA: _____
(SPECIFY AIR OR SEA POUCH)

DISPATCH NO. MGK-A-34572

SECRET
CLASSIFICATION

TO : Chief, Foreign Division M

DATE: 13 November 1951

FROM : Chief of Station, Karlsruhe *c/sg*

SUBJECT: GENERAL— Operational

SPECIFIC— KIBITZ 15 - PRQ, Part II

*do
8/1956*

*KOPP, WALTER
Op. clearance
14.20 Nov. 51*

Forwarded herewith is supplementary personalia regarding above subject
keyed to Personal Record Questionnaire form, Part II.

Distribution:

- ~~2~~ - FDM
- 1 - COS
- 1 - KOB

for []
SM/K

NAZI WAR CRIMES DISCLOSURE ACT

SECRET
CLASSIFICATION

FORM NO. 51-28 A
MAR. 1949

EXEMPTIONS Section 3(b)

- (2)(A) Privacy
- (2)(B) Methods/Sources
- (2)(G) Foreign Relations

Declassified and Approved for Release
by the Central Intelligence Agency
Date: 2005

SECRET

PERSONAL RECORD QUESTIONNAIRE

PART II

36. KIBITZ 15
37. Subject wrote a personal letter offering his services to Mr. McCloy, which letter was referred to us for follow-up. (MGE-A-21761)
38. Subject could be turned over quickly to someone else for handling.
39. His motivations are best identified as a desire to be active in the pro-German, anti-Communist, pro-West controversy.
40. Cleared by ELS, CLS, FIM and COS.
41. Case officer's control, permission, and assistance to fight subject's private war for Germany against Communism.
42. He is given to understand that he is working on a direct US military assignment to develop special stay-behind net. (MGE-A-23187)
43. No previous intelligence history.
44. Subject does not produce information. (See Item 42)
45. Recruiting and developing stay-behind net.
46. No special training given.
47. Not applicable.
48. DM 1000 per month plus travel.
49. Subject will be evacuated in our interest.
50. No
51. Upper middle class. (Professional officer - Corps Engineers)
52. No known bad habits.
53. Observed to be excellent.
54. Any western power fighting Communism. (Allied with Germany)
55. Well schooled in military training and tactics.
57. Subject filled out Part I by himself.

SECRET

AIR

SECURITY INFORMATION

MKKA-11841

6 December 1951

Chief of Station, Karlsruhe
Attn: []
Chief, FOM

KIBITZ 15

1. This memorandum results from a review of the file on KIBITZ 15 and will gear into the general PASTINE dispatch being sent to KCB by [] insofar as this dispatch deals with K-15.

2. Since []'s dispatch deals with the security aspects of the K-15 network in a general way, and requests your consideration of this matter, we thought it might be worth our while to put some of our specific ideas on paper, primarily as an aid to you. Please take into account the fact that some of these ideas may be obsolete or the difficulties may already be solved.

3. The first thing that strikes us in reading over the entire K-15 file is the question of his motivation toward his staybehind operations. We are, of course, interested mainly in having the best possible staybehind units in Germany in the event of hostilities. We are not interested, except incidentally, in having any of those units develop into a core for a future German military machine. There is some indication that K-15's motivation is strongly divided between his erstwhile (and possibly persisting) Nazi or nationalistic leanings, and his desire to have a part in a nucleus of people who would have a large part in any rebirth of the German army. The question then becomes: Has he become thoroughly convinced of the need, from our point of view, of the separate nature of his staybehind operation and of the unlikelihood that his outfit can ever become a part of a German army?

4. Secondly, there is mention in MKKA-23107, Para. 5, that K-15's tactical deployment of his agents is somewhat out of line with your thinking on staybehind activities. This may not exist at present, but it is worth thinking about, particularly in view of present thinking here in the direction of having staybehind activities determined largely by the targets to be attacked. K-15's use and deployment of agents must therefore be in harmony with whatever priority targets we decide upon, as well as in harmony with other PASTINE units. This is especially true since he is running his own show and could easily get out of bounds.

NAZI WAR CRIMES DISCLOSURE ACT

EXEMPTIONS Section 3(b)

- (2)(A) Privacy
- (2)(B) Methods/Sources
- (2)(G) Foreign Relations

CHIEF-KOB
PLEASE REPLY
8 JAN 52
[Signature]

Declassified and Approved for Release
by the Central Intelligence Agency
Date: 2005

SECRET

-2-

5. In MCKA-21761 K-15 mentioned his knowledge of other staybehind outfits. Presumably he had ZIPPER in mind. It is apparent from perusing the dispatches that it is felt that his units do not involve either ZIPPER outfits or others of our own. This has been mentioned before, and is mentioned again simply because it is extremely essential that the KIBITZ complex be completely divorced from any German outfits. Human nature being what it is, it is entirely possible that K-15 might have tipped his hand to ZIPPER personnel, or vice versa.

6. As we have said before, K-15 is pretty much on his own, and has been doing a fine job of developing what could be a valuable network. This, however, makes it all the more important that he not be permitted to run a little ZIPPER outfit of his own, without adequate control on our part. You know better than we do how far you can let him go in his organizational ability.

7. We hesitate to keep sending dispatches which necessitate more paper work on your part, but on the other hand, we assume that more attention here to PASTIME activities will be welcome.

[]

SECRET

Courier

MKG-A-

SECURITY INFORMATION

B

Chief, KOB

10 December 1951

Chief of Station, Karlsruhe

Operational

Evaluation of KIBITZ-15

Reference - MKG-A-35595

1. We have scanned the subject material rather hurriedly and may state that we agree most definitely with the strictures made by on "Page A."

2. Curiously, the subject material which looks like a crazy jumble at first, shows a great deal of talent and even a realistic appreciation of many of the things that stay-behinds have to know, do and avoid. If the subject material were to be cleaned up by a professional and tailored to the needs of the various members of the team, some 25% of wheat could be separated out of the 75% of chaff. More specifically:

- (a) Re enclosure 1: Could be cut down to size and leave something useful. We can just see the kind of German to whom KIBITZ-15 appeals therein;
- (b) Re enclosure 2: " " "
- (c) Re enclosure 3: " " "

(d) Re enclosures 4 through 12: These should be re-edited so as to make it clear to the recipients that it consists of several phases - elementary training in the basic precepts of observation; elementary methods of distinguishing between trivial, useful and really important intelligence; and instructions against reporting the trivial by E/T or the useful unless no more important intelligence is available for sending. The way these enclosures are written, they are likely to mislead rather than lead the recipients in the fundamentals of selection and evaluation;

NAZI WAR CRIMES DISCLOSURE ACT

EXEMPTIONS Section 3(b)

- (2)(A) Privacy
- (2)(B) Methods/Sources
- (2)(G) Foreign Relations

SECRET

B

Declassified and Approved for Release by the Central Intelligence Agency

Date: 2005

SECRET

- 2 -

- (e) Re enclosures 13, 14, 16: We are in no position to pass on these in view of our lack of knowledge of the identities and backgrounds of the individuals to whom they are addressed;
- (f) Re enclosure 15: This appears to be operational information concerning the members of the team referred to in your cover letter;
- (g) Re enclosure 17: The map reading code may be all right if it is intended to save time or space. It could be dangerous if it is intended to camouflage the locations, since it must be assumed that this aspect of the code could be broken extremely easily;
- (h) Re enclosure 18: Concerns reports writing and is a fair job for an amateur. No doubt Washington could improve on this.

3. Here and there KIBITZ-15 has brought in not just chaff but downright dangerous ideas and concepts. The one that strikes us as most absurd concerns the instruction to the recipients to seek out individuals for denial to the enemy by means of a "helicopter." We imagine that ZAGACTUS must be working on the general subject of removing important documents and bodies by plane - probably by the hook and wire method - but find the notion that one could use a helicopter and in this type of context betrays a strong element of naivete in the make-up of KIBITZ-15.

4. It strikes us that KIBITZ-15 could be turned into a valuable asset of the stay-behind program if he were to be given a 60-90 day training course in the various fundamental subjects concerning the business. The ideal place for such training would be in the U.S. and we suggest that you query FIM as to the chances that facilities for this sort of thing would be set up in the course of 1952.

[]

SECRET

SECRET

- 1 -

!!! ~~TOP~~ SECRET !!! This file is ~~Top~~ Secret, under the provisions of law. Keep it in a secure place. No other person is authorized to know of it or where to find it. When in danger of any kind, it is to be completely destroyed by burning. Always remember that the compromise of this file would threaten your life and the lives of your comrades, and delay the freedom of your people.

!!! TOP SECRET !!!

20 August 1951

Organizational Sketch With Cover Numbers:

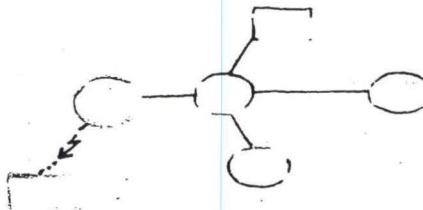

BURN when this is clear !

SECRET

SECRET

- 2 -

CONTENTS

On the preceding page: Organizational Sketch
Time Plan

Enclosure

1. Fundamentals
2. Commentary on Fundamentals
3. Our Objective
4. Means of Reaching Our Objective
5. Questions: Politics and Government
6. " : Economics and Industry
7. " : Propaganda and Influence
8. " : Treatment of Population
9. " : Enemy Exploitation, etc.
10. " : Transportation and Communications
11. " : Military
12. Area and Scope of Operations (a) General Examination
13. (b) Mission of Leader, Troop
14. Radio Orientation (Destroy Immediately)
15. Personnel Orientation (Destroy Immediately)
16. Copies of Instructions to Group Members
17. Map Location Reporting Method
18. Reports Writing - Sample Reports
- 19.
20. Aerial Photographs
21. Reports Map with Grid
22. Working Map, 1:300,000
23. Detail Map, 1:100,000
24. Acknowledgement of Secrecy Obligation
25. File Receipt

SECRET

SECRET

Enclosure 1

Always Think of This And Act Accordingly :

FUNDAMENTALS

You are a member of a great fellowship, which has dedicated itself to achieving and maintaining the freedom of our homeland and people.

Always remember that.

Every error, every false step on your part threatens the safety and life of yourself, your family and your comrades. But not only this! Thoughtlessness or indiscretion on your part could destroy our mission, our objectives, and all that has already been accomplished. As a result, you, your comrades, and all who come after us could enter into eternal servitude and slavery.

Therefore always hold the following points in view. Above all, take care in conversation. Act accordingly and check yourself daily to see if you have followed them minutely:

1. Silence
2. Don't Be Communicative
3. Be Distrustful
4. Be Deliberate; Act With Prudence
5. Don't Collect Incriminating Material
6. Loyalty and Comradeship Are Your Highest Honor!

Ask yourself today and every day until we have attained our objective:

"Have I observed the six fundamentals?"

! Always Think of This and Act Accordingly !

SECRET

SECRET

Enclosure 2

Always Think of This and Act Accordingly !

Closely examine the six fundamentals which are set forth on the previous page. They say much!

1. Silence :

Not even your wife, father or best friend may know that you are also working on other tasks for our ideals. Never say anything to them. They will disturb you and your work, and certainly will not remain silent.

2. Don't Be Communicative:

Not only vis-a-vis foreigners and strangers. No!! Even your comrades and co-workers may not know more of your affairs than is necessary for them in their work.

3. Be Distrustful:

Your supposed best friend can also be a traitor. Perhaps you were careless and a close friend was placed on your trail as an informer. Trust no one! You can't read minds.

4. Be Deliberate; Act With Prudence:

Every statement and any unusual behaviour could betray you. Reflect on every word and action. Think things through before you begin and be prepared to deal with the consequences.

5. Don't Collect Incriminating Material:

Every piece of paper, even the smallest, could make you a traitor. When you have finished an assignment, do away with everything - papers, tools, etc. that you no longer need. Burn it and satisfy yourself that the last remnants are taken care of.

6. Loyalty and Comradeship Are Your Highest Honor!

Our work requires good men. It cannot be done alone. Together we will achieve all. Your co-workers, your comrade is therefore your most prized possession. Help him however and wherever you can.

And if you are discovered, prefer death to betraying a comrade!

SECRET

SECRET

Enclosure 3

OUR OBJECTIVE

A united, free and equal Germany in a united Europe, member of a peaceful world without fear of oppression or want in any form.

We love our people and their way of life. We have committed ourselves with the last fiber of our hearts to the preservation of this way of life. Only in it can we live and work happily and freely for our own progress and that of all mankind.

Our own experience of recent years compels us to dissolve the narrow framework which has heretofore encompassed our thinking. In an age of rockets and atomic devastation our narrow national borders are economically, as well as politically, outmoded. A leaning toward a greater, actually existing union is therefore indispensable.

For almost 2,000 years our people, as most European peoples, have belonged to the occidental-Christian cultural community. As an unfortunate consequence of the power politics interests of individual ruling families and of opposing ideas and nationalistic, narrow-minded motives on the part of the people, this community has never led the way to political unity. While Europe mangled herself during centuries of national wars, large areas in the rest of the world banded together politically and today speak with the voice of authority to the entire world. It is finally time that the new young blood of all Europe work together to strengthen the political unity of the old continent. We feel ourselves to be an active part of this movement.

Europe is the mother of the white inhabitants of all the Earth - of almost all of the North American and Australian populations, as well as of the leading segments of the populations of South America and South Africa.

They are children of Europe and therefore children of the occident, a constituent part of the west in their spiritual and moral concept of life.

With regard to the known, monstrous danger from Asia, which today controls more than half of mankind, we appeal earnestly to a higher, spiritual, economic and political unity of these occidental peoples on the level of the UN or a multilateral, expanded Atlantic Pact.

We do not hate the peoples of the East. Nevertheless, their system of unconditional control of will and thought, and of absence of social, economic, political, and particularly personal, freedom is foreign and incompatible to us. We fear their clear intention of subjecting all of mankind to this system, and we are compelled in sheer preservation to band together with the free peoples of the Earth to combat it with all means at our disposal.

SECRET

SECRET

- 6 -

Enclosure 3 (cont'd)

Only in a western, occidental world are the hypotheses for freedom in equality advanced. In it we wish to live and let live.

The East is arming and is preparing an all-encompassing revolution. This is always destructive. We, as parts and members of a development of centuries, desire a further development, an evolution for all mankind, based on historic, cultural, economic, social and civilized achievement.

Thus our first goal can only be: A united, free and equal

Germany in a united Europe, member of a peaceful world

without fear of oppression or want in any form.

Committing oneself to labor for this freedom, unity and equality is well required. We want to, and will, work for it, since:

"Our Life Belongs Only To Freedom".

SECRET

SECRET

- 7 -

Enclosure 4

Our Way to the Objective

"Our Life Belongs Only To Freedom"

Was this not the final inference of our "Objective"? And yet the Russian is still here and the contrary is in reality coming into being. Right! You want to fight against it. Do it with your mouth or pocketknife and a shot in the back of the head or Siberia is a sure thing for you! Be smart this time!! Work with the new authorities, follow their instructions and simply lead your normal life. At the same time:

!!!? " See all , Hear all , Say nothing " !!!

and inform your comrades, who are preparing for your liberation in the West, of all that is known to you which is of importance to them in the preparation for liberation and the achievement of our objective.

And that would be:

1. What changes are being made in the field of Government and Politics?
2. What economic regulations are in effect? What industrial plants are in operation? Does the money have buying power?
3. What new propaganda themes are being spread?
4. What mistakes are being encountered in the handling of the people? What former policies are now considered to be outmoded, and what is being regarded as pleasant innovation?
5. Are there any well known politicians or significant scientists, engineers or construction specialists in your area whose work could be of importance for the enemy?
6. Transportation, Commerce? What is going where on the roads, railroads, the Danube, tributary streams, in the air?
7. Military? Movements, troops, weapons, airfields, camps, training, staffs, officers, military construction, morale, passwords, etc.???

In particular:

SECRET

SECRET
- 8 -

Enclosure 5

Questions in the fields of Government and Politics

(The following questions are check points for your reports. Observe)
(changes and innovations, reporting only that which is of significance.)

1. General Questions on Government, etc.
 - a) What radical changes are being or have been made?
 - b) How were mayors, county councilmen, Land presidents, etc. treated? Where are they? What was done to officials and administration employees?
 - c) How are the government posts now occupied? Where do the mayors, cabinet personnel, etc., come from?
 - d) Was anything changed in the governmental organization? How does the administration function? Are the new officials corruptible?
 - e) Who directs the administration? Germans or Russians?
 - f) What became of the police? Who took over their functions?
 - g) Who is in jail? How are conditions there?
 - h) What has become of the courts and judges?
 - i) Who administers the courts? Judges? Who delivers decisions?
 - k) What are conditions in the finance offices? Is anything known regarding a new tax law?
 - l) How were land and property registration offices effected?
 - m) Effect on labor, building, agricultural, street traffic and business offices?
 - n) What is known about other offices and officials?
2. General Questions on Internal Politics, Party Conditions, Press, etc.
 - a) Fate of the political parties? Of registered members? Of party officials?
 - b) What party activity is allowed?
 - c) What unification measures are being propagandized by the Communist party? What ordered?
 - d) Do newspapers appear regularly? Which ones?
 - e) Are outspoken non-Communist opinions permitted to be published in the papers?
 - f) How did it go with the editors of formerly non-Communist papers?
 - g) How are different segments of the population being treated, ie, farmers, handicraft workers, store employees, technicians, officials, disabled veterans, pensioners, priests, teachers, etc.?
3. General Political Questions (also see "Propaganda")
 - a) In comparison with earlier Red propaganda, is a new political policy recognisable?
 - b) Which nations are most often praised in word and print, which are being courted, which excused? Which, in their own power sphere, are most often attacked?
 - c) Are any new motives noticeable in comparison with former press and radio propaganda?
 - d) Is there anything in the field of foreign affairs which is being passed from mouth to mouth while not being heard on the radio? Are rumors prevalent?

SECRET

SECRET

Enclosure 6

Economic and Industrial Questions

(The following questions are only points of guidance for your reports. Observe only changes and modifications which are actually in effect, reporting only that which is of significance.)

1. General Economic Questions

- a) What economic changes are being made?
- b) Has there been any deprivation of property or change of ownership?
- c) What firms had to close?
- d) What grounds have been given for these closures?
- e) What has happened to the banks and saving institutions?
- f) Have banking enterprises been merged or consolidated?
- g) What has happened to savings and bank debts?
- h) Is credit still extended? For what purposes?
- i) What is the purchasing power of the DM? Is it constant?
- k) What is the most sought after means of payment? Exchange?
- l) How much do bread, potatoes, meat, lard, eggs and vegetables cost?
- m) What steps are being taken toward economic revival?
- n) What economic needs and restrictions can be determined? What material is particularly sought after? What foodstuffs are lacking, are being produced?

2. Questions Regarding Agriculture, Handicraft, Commerce and Stores

- a) What changes are being made in these branches of the economy?
- b) Are farmers subject to compulsory planting and cattle farming regulations? Of what kind?
- c) Are machine unions required?
- d) What are price and marketing regulations as applied to farmers?
- e) What agricultural produces are being stored? Where?
- f) What new jobs do the sundry commercial firms have to fulfill?
- g) What commercial warehouses are being erected? Where?
- h) Has the handicraft industry acquired new tasks to be done? Which?

3. Industrial Questions

- a) Which industrial plants are again in operation?
- b) Which plants have been closed or moved?
- c) Have any plants been consolidated? Machinery exchanged?
- d) Have any particular manufacturing branches become particularly important?
- e) What is being manufactured, and where? What innovations? Where?
- f) Where have personnel changes and exchange of technical workers appeared?
- g) What new industries are being built? Where?
- h) What new industries are planned? What is being talked about?
- i) Have the top directors and engineers remained in their jobs?
- k) What other recent industrial information is known?
- l) Plans and formulas of all and every industry could be decisive in our flight for liberation. Work at it!

SECRET

Propaganda and Population Influence Questions

(These questions can only serve as points of reference. In this field no precise questions can be posed, inasmuch as it covers all fields of public life. Observe only changes and modifications. From them future intentions of all types may be deduced.)

I. Orientation Questions of a Technical Nature:

- a) What appears to you to be the particular characteristics of the new propaganda, ie, in method and content?
- b) Name the propaganda and news sources which are known to you, ie, a certain newspaper, a particular official authority, etc.
- c) Using examples, distinguish the difference between propaganda lines spread by means of radio and press as opposed to those passed by word of mouth.
- d) Review the effectiveness of radio, the press, meetings, pamphlets, placards, loud speakers, open air films and weekly news films as propaganda media.
- e) Where are new radio stations being built; where is other propaganda serving work being done?

It is a valued principle of dictators to constantly loose a very few sharply defined propaganda these on the people, until such time as the last inhabitant of the remotest village must believe in their truth. Every change or modification in propaganda lines, therefore, must have a bearing on some proposed change in foreign or domestic politics, or in the economic, military and various other fields.

II. Observe therefore the motives discernible in the following points:

- a) What strikes you as being a change or modification of propaganda presentation, of press articles, of what is being spoken about?
- b) What is being praised, what is anathema, what is being criticized?
- c) What concessions are being made to one nationality at the expense of others; to one class at the expense of the others?
- d) What concessions are being made to the German public in the questions of the Oder-Niesse line, the Saar, and the western border?
- e) What appears more in the propaganda which is tailored for Germany:
 1. Pan Slavism (union of all slavic peoples) under Russian leadership?
 2. The European mission of Russia for the liberation of the working classes from servitude to western capitalism, with the aim of a united Europe - later Europe and Asia (Eurasia) - under Russian leadership?
 3. The world mission of Russia for the liberation of the working classes from capitalism - international (Bolshavik) revolution?
 4. The German-Russian brotherhood for the construction of an economic and military potential superior to that of the decadent West?
 5. A union of oppressed nations (Germany, Russia, Japan) banded together, at war with the West, with joint world domination as its aim?

In connection with these points, also see Enclosure 8.

SECRET

Questions Regarding Treatment of the Population

(The points discussed in Enclosure 7 have much in common with the matters to be dealt with here. Note that they also apply thoroughly to this section; above all note changes and modifications. They are of significant aid in determining further enemy intentions.)

In the following, always determine the difference between:

What was the official intention?
What is the actual situation?

- a) How is the indigenous population to be treated?
 1. Are they to be weaned away from their previous loyalties by gentle persuasion and won over as sincere friends?
 2. Are they to be compelled by force and/or fear to become complaisant members of the new order, or
 3. Are they to be regarded as enemies, to be dealt with or left alone as seen fit?
- b) What is regarded by the people and pleasant, as new and pretty?
- c) What is looked upon as ridiculous and outmoded? What in previous human life can they no longer understand?
- d) Name the points which brought friends to the new system. Name the events which caused this system to lose its sympathisers?
- e) What effect does permanent party and military influence have on the morale and attitude of the people?
- f) Which class, race and peoples is/are regarded and treated as friendly, which as enemy?
- g) What is being done to or with former German professional soldiers, veterans of the war with Russia, police members, eastern refugees, former Nazi and SS, etc. members? With their dependents?
- H) Which class is being obviously catered to? Which is threatened with force?
- i) How are the various younger age groups faring?
- j) Fate of the various religious groups; churches, clergy, other installations?
- k) What has been the effect on welfare organizations; on their hospitals resorts and other physical plants?
- l) In what form have youth, hiking, sport, singing and social organizations continued to function?
- m) What type of clubs and other group activities is forbidden? Is supported? Has been changed?
- n) Imagine once the unpleasant circumstances resulting from occupation and war in all aspects of public and private life — try to determine what the people lack, what they particularly miss.

SECRET

SECRET 12 -

Enclosure 9

Who and What Can Be Of Use To the Enemy?

1. Important scientists, noted construction personnel, top engineers and architects, industrial coordinators and other types of experts have an importance for the enemy which cannot be overlooked. They can effectively help him with new inventions, solution of economic and other technical problems, and with the development of new production methods.
2. Specialists such as surgeons, medical specialists, meteorologists, geologists, botanists, chemists, etc., key railroad personnel, boat pilots, etc. and their representatives could prove to be of utmost assistance to the enemy.
3. Well known politicians, important clergymen, popular sportsmen, government officials, doctors, teachers, etc., who were formerly non-Communist but become seduced by their propaganda into declaring themselves with the enemy, can thus provide more water for the propaganda mill and aid in influencing the general population.
4. Well known, outstanding and popular soldiers, highly valued officers, pilots, submarine captains and recognized infantry and tank officers could serve him by dint of their previous military status, and increase his influence by openly avowing his cause.

Note the people in your area who could be of use to the enemy and ask yourself:

- a) Who can be of use to the enemy? How does he profit?
- b) Is he who helps the enemy actually for or against him?
- c) Does he work under pressure or out of fear for himself and his people; does he make himself available for enemy propaganda exploitation and influencing of the population on these grounds, or does his cooperation reflect an actual conversion to their political ways?
- d) Can you discreetly approach him, or do you have contact with him through other persons?
- e) Do you think you could get him to agree to leave the country by means of an aerial pickup (helicopter) at a certain time and place?
- f) Assuming your friends could place an airplane at your disposal, could you with discretion arrange the details of such a flight; ie, choose a landing field, provide armed security for the landing, brief personnel concerned, pick up and deliver the evacuee to the proper place, etc.?
- g) If he is for the enemy or is suspect of too thorough collaboration, think of other means of eliminating him:
 1. Denounce him anonymously or through a middleman on the basis of former anti-enemy activity.
 2. Again anonymously or through other persons, denounce him with the use of imaginary private or public scandal. We know from experience that the new masters seize on that kind of thing.
 3. Spread rumors of concentration camp or other damaging activity on his part.
 4. Threaten him against further collaboration by the use of anonymous letters of different types.
 5. Use any possible means of doing away with an enemy collaborator.
- h) What goods, valuables and provisions are of profit to the enemy? Where? Do not forget, in war the method is unimportant. Only harming the enemy is of any worth - in any way and wherever I can!!

Transportation and Communications Questions

From the comings and goings of means of transportation, economic, industrial and, above all, military intentions and trends can be given a timely evaluation. Internal German small supply transport is not of interest. Once again note particularly changes and innovations

in the type of goods dispatched
in the means of their transportation
in the reason for their being shipped
in the origin of the goods.

In each of the following explanatory points, ask:

What? With what? Whence? Whither?

- a) What is moving on the roads? On the railroads? What is being shipped on the Rhine and its tributaries? What do you know concerning air-transport? Where do the goods concerned come from? Where are they going? Where are they unloaded and stored? Where did they come from? Where are they going?
- b) If the transports are guarded, how strong and by whom? Are raids on such vehicles known to have occurred? Large thefts?
- c) Where are the large camps and depots of the individual transportation channels? What is stored there?
- d) Where are central locating points for large trucks, locomotives, rail transport material, transport aircraft, ships and small boats? Normal quantity?
- e) Where are means of transport being maintained? Where are roads and railroads being improved?
- f) Where are secondary roads or paths being strengthened or paved? Where are new roads, road section and non-through roads being constructed?
- g) Where has a new road sign been erected? Wording?
- h) Where are major roads, forest thoroughfares and routes through villages established for the use of convoys? Where are the signs indicating such routes?
- i) Where is new railroad construction, improvement of railroad stations, switch installation, improvement and enlargement of loading ramps, clearing of seldom used ramps, and building of approach ramps taking place?
- j) Where do freight ships and small boats receive drydock service?
- k) Where are bridges being cleared to permit through river traffic? Where is any increased dredging work taking place?
- l) What ports, moles and docks are being improved, strengthened?
- m) Where are new cranes being mounted? What do they carry?
- n) What airfields are being repaired, lengthened, built? How long is the runway? Where are the runways being strengthened with pavement? Where are aircraft warning lights, landing lights, etc., being constructed? With what type of aircraft is freight being carried, what do they carry, where are they stationed? How many are there?
- o) Where is a pipeline, ie, a fuel conduit system, being built?
- p) Where and how are transportation routes being camouflaged against observation from air and ground
- q) Between what points are cable or telephone lines being installed? Where are radio stations, police or news transmitters? Do you know their purpose, strength, frequency or wavelength, time of transmission?

SECRET

SECRET 14 -

Enclosure 11

Military Questions

It is impossible to provide questions other than of a general nature in this section. Proceed on the following basis: everything that the enemy does is connected in some way with impending or planned developments in the war. Therefore military matters are of utmost significance. It is impossible to overestimate the necessity of absolutely accurate reporting in this field. The more exact the report, the more precise is the resulting overall picture which serves as a foundation for subsequent offensive and counter measures. Three groups of example questions follow, in order of their importance.

Group I is of more importance and significance than all material that we have covered up to this point. Concentrate on these points, to the extent that your knowledge of them will adequately serve your specific station.

- a) What is known of new weapons? What is rumored among the troops, among the population? What has been made known officially?
- b) Are any rocket launching sites known? Where are rockets (V1, V2) stored?
- c) Where are airfields for long range bombers and other wide range aircraft? Those with the capability of remaining aloft 30 to 40 hours?
- d) Where are atomic weapons - bombs, grenades and the like stored?
- e) Where has any group of special troops appeared, ie, a detachment segregated from other troops and from the population? (A large body of police usually accompanies such units.)
- f) Where are any military scientific research or operational staffs located? Is there any talk of cosmic rays, ie, space rays? Where is there discussion of bacterial diseases and their dissemination by use of weapons? Where is work being done in the chemical warfare field, ie, pulmonary, nervous and/or contact poisoning systems? Where is glaciation or freezing being discussed? Where is talk of other types of weapons derived from the fission of energy? Where is there talk of new anti-aircraft methods, such as the use of rays, rockets, acoustically self-guided missiles, etc.? What is being said about tanks being propelled by atomic power or water? Where is anything heard regarding new direction-finding equipment, guided missiles, radar-radio installations, acoustically or radio controlled rockets and aircraft? What of things generally that are new and unknown to you?
- g) Are there troops or equipment anywhere which have to do with the things mentioned in f) above?
- h) Can you recognize strategic staffs of any army or air force; ie, those headed by a General of the Army, by an air force General, by a Colonel General, or by a Marshal? Determine the exact designation of the staff, the name of its chief, and its location.
- i) Where can a concentration of materiel or troops be recognized? Where are long columns of military goods and various types of weapons being transported? Where unloaded? What wooded areas are occupied by troops? What kind of troops? Are approximate number of tanks and weapons and extent of rations known?
- k) What is known concerning open or defeated mutinies among the troops? Of population uprisings at or behind the front?

Group II is equal in importance to the main questions of the other fields. Of greatest importance is determining and reporting unit designations. Nationality is also of significance.

SECRET

SECRET - 15 -

Enclosure 11 (Cont'd)

- a) Where is any staff which is headed by a General? Name, nature and description of the troop unit concerned, the staff, the General?
- b) Where are the staffs of armored, infantry and rocket divisions located? Where the troops? Where the armament?
- c) Where are paratroop and airborne ground troop units? Armament? Where are their air transport units? How many?
- d) Where are other troop staffs? What unit? What strength? What armament? Nationality of officers and men?
- e) Where are bomber, attack and fighter aircraft installations? How many machines? Is this constant?
- f) Where are central supply points? Where and how are foodstuffs stored? Is the packing gas proof? Where is fuel stored? Where are railroad tank cars and tankers unloaded? Where are munitions and bomb depots? Where is chemical, gas and bacterial ammunition stored? Where are rockets stored? Where are other munitions and materiel depots located? Where are aircraft, tank, artillery and other repair shops? Where is engineer equipment stored? Bridge construction parts? Mines? Fortification machinery? Building machinery? Dredges? Tools?
- g) Where is fortification work being done behind the lines? Where are bunkers of all types being built?
- h) Where are indicated and non-indicated medical installations, such as general and field hospitals, resort establishments, etc.? Where are specialized hospitals for the treatment of gas, atomic or bacterial poisoning?
- i) Where are enlarged anti-aircraft units being deployed? What is their armament? Their nationality? What AA support units are attached, eg, radar and searchlight troops, other aircraft warning personnel, etc.?
- k) What do you observe in the field of communications? Large radio stations? Radio direction finding and radar troops? What telephone circuits are being used? What postal circuits?
- l) Can you procure even the smallest details in the field of radio; eg, concerning frequencies, wave lengths, transmitting strengths, secret codes, coding devices or methods, etc.?
- m) What do you know about magnetic direction finding of large masses of steel? Of measuring by use of light and sound?
- n) Try to get an insight into the activities and orientation of the troops. For what are they trained? What are they practicing? For example: tank attacks with transported infantry, attacks on towns, attacks through woods, attacks in the mountains. Utilization of difficult terrain, infiltration, envelopment, river fording, crossing mine fields, etc.? Recognize what weapons work together, and how the troops are armed. Are the troops practicing camouflage, fortifications construction, building dummy installations, use of heavier infantry weapons (hidden or flanking machine guns, anti-personnel cannon), entrenchment of tanks? Are the troops being trained in a different manner than before? Can you determine the exact nature of the change and its significance?
- o) Can you ascertain the morale of the officers and men - their attitude toward Communism, toward the west?

Group III is equal in importance to the other fields already treated.

Obtain and report all other military information of significance; everything that appears to be new, sudden or changed in troops, armament, training, conduct, attitudes, etc.

SECRET

SECRET - 16 -

Time Plan

Time : Now

1. The accompanying overall plan and the radio will be given to you in a case filled with medicines. Secure handling is recommended.
2. A letter concerning the location of these things will be given to you. This letter contains instructions dealing with the attack which by that time will have been launched. Open only when an attack from the East has actually taken place.
3. This missing signal plan, as well as all the necessary radio material, remain at the home of the author. Successor in the affair has instructions to deliver the sealed package located in the safe to you, having no indication of the nature of the contents.
4. If, contrary to expectation, the material is not delivered to you by this means, have one of your co-workers pick it up at house 45 (Winter), in Rupp's neighborhood.

Time : D-Day You will have all necessary materials in your possession, i.e:

1. A Leitz folio with five enclosed folders, giving plans of activity for yourself and your collaborators.
2. A complete radio set in a metal container, with spare parts, etc.
3. A complete signal plan with all necessary materials.
4. Medicines for your unrestricted use.

Your mission is clear from the first day:

You, or an absolutely reliable man charged with the task by you, must provide the defense against the East with constant orientation, within the framework of the reporting plan accompanying the radio set.

Only by being thoroughly informed can we conduct and successfully conclude a war with the East.

- To be done:
1. Acknowledge receipt of your copy of the file (Enclosure 25).
 2. Please sign the secrecy agreement (Enclosure 24).
 3. Keep both available, in the event a courier visits you to claim them. With him you can discuss details and clarify any matters as required.
 4. At that time it might be opportune to discuss:
 - a) storing of the radio set,
 - b) state of training and availability of the radio operator,
 - c) first reporting day, if not already passed,
 - d) points worthy of attention on the basis of hostilities up to that time.

SECRET

SECRET - 17 -

Time Plan (Cont'd)

- e) thorough discussion of the mission
 - f) consideration of Enclosures 14 and 15, after which both are to be destroyed immediately
 - g) Any further questions!! It will be your last chance to ask them.
5. And now you're on your own: Independent and authoritative leader in an important post, and from now on sharing the responsibility for, and helping to shape, the prosperity or misery of people and homeland.
- Always keep this in mind, and ask yourself every evening: Have I fulfilled my duty today to the Fatherland and our people? How have I hurt the enemy?
6. Now hide everything so well that not even an Ivan can find it!

Familiarization: (D-Day plus 8-14)

1. You now have your first impression of Ivan. Get used to him!
 2. Don't forget: you must obtain a good position with him, you old Communist.
 3. Now remove file from your folder and work on the schedule. Page 1: when all is clear and settled, Burn. Pages 2 and 3: take care of and remove. When the points are settled, Burn. And so forth.
 4. Go through Enclosure 13 with reference to existing conditions. Fulfill Enclosure 13 and the remainder of the Time Plan.
 5. Your greatest concern is, and will remain, the recruitment and welfare of your radio operator. Help him wherever and whenever you are able.
 6. Work through the plan systematically. My suggestion:
 - a) first the general orientation portions: Enclosures 1,2,3,4.
 - b) then your special instructions: Enclosures 12, 13, 14, 15.
 - c) the general question fields: Enclosures 5-11. (always of interest)
 - d) the tasks proposed for your co-workers are important in determining your decisions. Enclosure 16.
 - e) and finally, train yourself with the aid of Enclosures 17 and 18. It will definitely lighten your working efforts.
 7. Don't collect incriminating evidence. Ivan is looking! If not already done, burn the organizational sketch at the front of the file, as well as Enclosures 14 and 15.
 8. Then, when you have taken care of everything else, go through the whole business again from the beginning in order to obtain the complete picture.
- Be generous with what seems to be superfluous — Burn it.

SECRET

~~SECRET~~ - 18 -

Time Plan (Cont'd)

Instructions for Radio Operator: (D plus approximately 3-4 weeks)

1. Using all possible security precautions, check the operator's orientation and suitability. If you have only scanty information on him, wait a week or so.
2. If he proves to be suitable, go through the appropriate files with him. Conduct regular instructions, satisfy yourself that he has complete mastery of the material required and that he fully understands his job.
3. Unpack the radio, again satisfying yourself that he is fully capable of servicing and operating it.
4. Divide the weapons and ammunition between yourselves.
5. The money enclosed with the signal plan is to be equally divided three ways: to you personally, to the operator, and for unforeseen emergencies, bribes, payoffs, etc., as required. If you should decide to operate by other methods, divide the money as you see fit.
Remember that this money is not a payment, but an emergency fund to assist you in your work. Fulfilled duty is your payment - and after fulfilled duty, material and idealistic reimbursement are surely yours.
6. The radio materials are to be given to the operator. (Radio material chest).
7. The set and other radio materials are to be hidden separately, and moved as often as feasible. The set must also be quickly available when needed.
8. Now, observing the greatest possible security, let your operator work with the set in conjunction with the other materials. Take care that he always knows the following exactly:
 - a) times of transmission
 - b) sending and receiving frequencies (Signal Plan)
 - c) appropriate codes.
9. When he has advanced that far, determine the day on which you will make your first radio contact (following the signal plan), as well as the meeting place for the preparation and encoding of your reports.

After About 25 Days (first contact establishment):

1. Prepare your reports in advance. Encode them completely and determine order of transmission.
2. Send your first report according to the signal plan. (Base station will stand by for reception after D plus 14).
3. When you have once made contact, do not let it break off again until the final liberation of our people and our country.

~~SECRET~~

SECRET 19 -

Time Plan (Cont'd)

4. Insofar as possible, convince yourself of the accuracy of all reports, rumors, etc. Check as well as you can that the things you hear are factual, so that the most exact reports possible may be forthcoming.
5. Practice reports composition, make the utmost profitable use of all transmission times.
6. Decide on the basis of the situation whether the radio operator is to work alone, in your presence, or in the presence of a collaborator chosen by you.

After One or Two Months (choosing collaborators):

1. By now you have acclimated yourself to prevailing conditions. Nevertheless, be careful. A false sense of security will throw you off your guard.
2. In peacetime we selected other persons as being suitable for our work. Are they still suitable today???
3. Consider this question carefully and do not answer it lightly. Too much depends on it.
4. When you are convinced that you need someone, and believe that you have found the right person, determine:
 - a) for what duty is he needed?
 - b) what will be his exact function?
5. Take your co-worker file out and adapt it to this function. In it leave only matters pertaining to the specific job. Burn everything else. (Files)
6. Brief him on the basis of the file; go over his assigned mission, the enclosures which pertain to his activity, and map reading, thoroughly.
7. Check again the things you entrust to him. The less, the better.
8. Once again - you alone make the choice of taking in other personnel. The names I provide are merely suggestions.
9. Finally, you alone can decide whether you are in complete control of the operation, or whether you have discovered an outstanding man who can better dedicate himself to the task at hand. You decide!!

Always remember:

1. You stand on your own feet and operate independently.
2. In this position you share responsibility for the fate of our people.

SECRET

SECRET

- 20 -

Time Plan (Cont'd)

3. Your responsibility is great! Treat nothing as if it were in fun.
4. Your mission can only be accomplished with deliberation and caution. The resulting tedium is part of the bargain. For remember,
5. Few reports are better than none at all.

Other Important Points:

1. Check all paper and supporting documents for superfluous material.
2. Burn everything that is unnecessary.
3. When our traffic is flowing, it is to be hoped that, aside from the maps and radio material, nothing else will be of importance.
4. Then will be the time to burn everything else. Remember: "Fire Doesn't Talk"!!

The future and the freedom of our people obligate the entrusting of this mission to you, known to us as an unshakable boulder. Our trust in you is boundless.

Therefore: "Forward, As Always" !!

Now, to the new task:

Good hunting and Tallyho !!

SECRET

SECRET

- 21 -

Enclosure 12

General Comments on Area

Carefully examine your working maps (Enclosure 22)

Area is located in the center of the Swabian-Bavarian high plateau. Its central point is - as it was earlier - Augsburg.

Examine a map of Germany or Europe, paying particular attention to the network of roads and railroad lines in southern Germany. You will soon see the importance of Augsburg and of the line Augsburg-Nuernberg.

The significance of this central location has been reduced by the recent construction of railroad line and road systems from Munich directly to the North and East.

Despite this development which centers around Munich, nothing can or will transpire in the area south of the Main and East of the Black Forest which cannot be pinpointed as a result of its crossing (East-West or West-East) the line Augsburg-Nuernberg, or (North-South or South-North) the line Guenzberg-Ingolstadt.

No one observed area can play a decisive role in world affairs. However, the area with which we are concerned has such a central location that any affairs taking place in southern Germany must make themselves known here.

It can therefore be said with justice that small details and matters of seemingly secondary importance which are to be observed here have a singular significance in contributing to evaluation of the general situation.

On the basis of present conditions, particular attention is to be given to:

- a) Railroad lines : Munich-Augsburg-Ulm, Ingolstadt-Gundelfingen-Ulm, Augsburg-Donauwoerth-Nuernberg.
- b) Roads : Autobahns Munich-Ulm, Munich-Ingolstadt-Nuernberg (to that point). Highways Munich-Landsberg-Memmingen, Munich-Augsburg-Ulm, Ingolstadt-Donauwoerth-Ulm, Augsburg-Donauwoerth-Nuernberg.
- c) Industries * MAN Augsburg, Keller & Knappisch, Osram, Messerschmidt, textile industry (all Augsburg). Wagon construction Donauwoerth, Dechtreiter-Baumenheim, Koedel & Boehm - Lauingen, Siemens-Weitingen. Lech-Chemie, Gersthofen, etc.

Thus you can see : Your area is important! What happens here must be reported. It will serve the final liberation of your people and your homeland!

SECRET

SECRET - 22 -

Enclosure 13

Assignment of Chief, Troop

Honored Doctor!

You have been committed to the good of Germany for many decades. You were an activist in the best sense of the word. From the corps of chasseurs, you overcame the burden of the second war and surmounted the terrible events of the immediate postwar period. You are finished with it all, and are now beginning your life over again.

You have tremendous numbers of contacts and influence, and you are held in great esteem. Receive as an indication thereof, your being entrusted with the knowledge of the task now laid before you, and your being requested to conduct it to its successful conclusion. It is completely up to you whether you wish to take command personally or relinquish it to other reliable persons.

You have now digested the foregoing and are informed concerning our desires. We cannot and will not deny our 2,000 year western history, without which we could not have risen to our present form and substance. We are children of the occident; as the heritage of our forbears, and despite all opposition we will remain so.

We are now in the position of assuming the historic mission of defending ourselves against the East - as our forefathers for the past 2,000 years have been before us.

Methods change, but not tasks and objectives.

Revolution was the answer in earlier times. Men took to the woods, organizing uprisings and group guerilla activities. Today these methods might achieve a measure of success in less civilized areas. For us it would be senseless for both the people and our country!!

We therefore suggest to you the wiser and more cautious methods:

- a) Adapt yourself to the ways of the East. Among the boys, be fanatic and toe the party line! After all, you are such an 'old' Communist.
- b) At the same time, sabotage everything possible. Work alone as much as possible. Provocation and counter-rumors are sabotage in the best sense of the word. Also undermining of discipline.
- c) But the most important thing is, help the prosecution of the war against the East, command and guide as our most important man in Swabia.

We have quietly trained the man you suggested as radio operator, and have prepared a radio set. Make use of both of them.

Your radioman is mentioned in Enclosure 15 of the plan packed with the set. Your set is the chest which has been delivered to you containing emergency medicinal supplies.

It is completely up to you, on the basis of the current situation to decide whether to take the persons named in Enclosure 15 under completely or partially into your confidence. It is your decision to make.

You must become the news phenomenon of Swabia. Report to me everything of

SECRET

SECRET - 23 -

Enclosure 13 (Cont'd)

interest having a direct bearing on the war, as well as things having only peripheral influence. Yes indeed, you report to me personally. It all can be condensed into: "The worst for the enemy, the best for our country"!!

Let us discuss a few commonplace things: Absolute secrecy vis-a-vis everyone. There are plenty of gabbers!!

Check over the plan at your leisure; you are not pressed for time. Adapt it to the present actual situation and improve it as you deem appropriate.

Don't be hasty. Look quietly at the new business: you will have a better insight into the matter when you actually become a chief activist.

The main thing is that your radio operator stands his ground; otherwise he will be out of touch. When conditions are secure, take the radio out of the chest and go through the radio materials with him. He has been trained in this work and should certainly master it in a short time.

Supervise him to make sure that he is discreet, that he handles the radio materials in a secure manner, and that he works with them in complete secrecy. Check to determine that he understands the following radio procedures:

- a) Times of transmissions (you always change)
- b) Appropriate frequencies (you also change) and
- c) Correct codes (for him to change).

When these preparations have been made, come up on the air about 3-4 months after D-Day on one of your assigned signal plan schedules. Believe me, contact will be established. I have already provided for it!

From now on you stand alone and on your own feet, co-responsible for, and co-decisive in obtaining, the freedom of ourselves and our people.

Report! Better little than nothing at all; we have plenty of time. Only report important and military information, as well as that which is of a decisive nature in the conduct of the war.

Let us have your thoughts also. Tell us how and where we can let Ivan have it. When the operation has been launched, then consider whom you require as snoopers, informants, reporters, spotters, etc. After checking him, the appropriate file is to be adapted to him and to his job. He is only to get what he needs; everything else is to be burned.

You and your radio operator must become one heart, one soul. Do that, and Germany can leave herself to you. And now, eyes and ears open! Recognize and report the important! Main mission: politics, military, railroad, traffic, supply. You, the north Swabian specialist. Think of your family for later, for it will never be your personal damage.

Good luck

Tallyho

The military friend of your house

SECRET

SECRET - 24 -

Enclosure 14

Destroy Immediately After Familiarization

Radio Orientation

1. Your radio set and your radio operator give you the only opportunity of contacting the outside world and hearing from your German friends there.
2. Your radio set is your most precious possession and your operator is your best friend. You belong completely to them. All must go well with your operator. He needs good nerves; make sure that he has them. Your set and materials must be immediately available and yet wonderfully hidden.
3. The most important thing with your set is the signal plan. Only with this plan does the radio have any value. Among other things, it contains:
 - a) Transmission times - the time during which someone is listening for you
 - b) Sending and receiving frequency - the wavelength on which you will listen and on which you will be heard.
 - c) Codes - the means of camouflaging your reports texts whereby only your base station can understand them.
4. Transmission time is short - a half hour at the most. It is also on various days, sometimes thrice, sometimes only once, a month.
 - a) Your traffic must therefore be short. 750-1000 letters are to be sent; during this time you will also want to receive messages.
 - b) In the event you have more than one report, the most important has priority. Order of precedence: military, traffic, industry, etc.
 - c) Adhere punctually to the contact schedule. Therefore the reports must be given to the operator far enough in advance. They must be encoded without worries about the deadline.
5. You have changeable transmission times, constantly changing sending and receiving frequencies, and a code which alters itself with every message. If at all possible, transmit from a different location each time. Your set is constructed to operate on all types of electrical power supplies, even on an automobile battery. That is not imposing unnecessary difficulties, but a measure of safety for you.

Remember! When your radioman is operating on frequency 800, every person in the world who in that moment is tuned to 800 can hear him. To keep such persons from understanding your messages, they are encoded.

But enemy radio direction finders have more interest in you, in your set and in your materials than they do in the reports. In order to pinpoint your location, you must be heard simultaneously by 2 or 3 direction finders which are at least 100 Km removed from each other.

It is practically impossible to do this if you follow your signal plan exactly. Even if the neighborhood is identified, a fine tooth comb search must be made to discover you. By that time you will have identified such searching parties and disappeared.

If you yourself are always suitably cautious and clandestine, it is unthinkable that you would ever be discovered.

So, operate accordingly - It's for Germany !!

SECRET

~~SECRET~~

Destroy Immediately

Enclosure 15

5 October 1951

Personnel Orientation

Plan is composed of an earlier established comradeship. Actual specialists, in the sense of the mission at hand, have not been drawn in.

- The troop leader is a man of affairs, is held in considerable esteem and has significant influence on his surroundings. By dint of their absolutely factual and sober content, his reports will probably show his clear understanding of all public and military questions. The plan will be brought to him. His decision will determine the further use of:
- Rupp, young farmer, a proven soldier, absolutely discreet, as reliable as his time will permit. He will not be able to contribute much in the way of his own personal knowledge; however, he is a good man for pulling together trivialities and details in a larger working area. Well known in his area. Good working possibility for the troop specialist.

Franz, hunter and poacher, excellent shot. Despite his simplicity in thought and action, he is cool and crafty. Not of too much use through his own knowledge and perception; however, he is the very man for courier and other menial type duties. Well suited for guard during radio transmissions.

- Young student, same name as Number . Unfortunately one of his eyes has been injured. Very amenable and perceptive. In the new era he may become well known through acquiring knowledge of various things which are otherwise not too well known. Should a tendency to become sedentary develop, he would be a suitable representative for He will work alone for months with the specialist for the purpose of further screening and concealment. This last will be particularly useful, since this troop is equipped with a small pocket radio set, which makes generally for very light work.
- Name of radio operator not yet finally decided. From the number available, the most quickly prepared and most reliable will be picked.

~~SECRET~~

SECRET - 26 -

Enclosure 16 - 2

Special Assignment for

Dear Rupp !

You're a sly dog and you've been through the mill, so you'll have to stand by and bear the brunt.

We know each other very well, so there is no need for either of us to indulge in preambles. We have often spoken of the way things will be when the Russians come. Our opinions coincide completely. Therefore we are again working together today, as so often before.

You have already read the preceding pages 1-9 and learned what we can and must do to hurt the Russkies. The most important thing, however, is to let them know on the outside what is taking place in Swabia, so that our people and our own land are not subjected to any nonsense.

1. You know your way around Swabia as no one else does. You have many acquaintances and friends. You know the people's attitude in the city and in the country, among farmers, poachers and workers. Report on it.
2. Since you have not yet belonged to any party, perhaps it will be possible for you to go along with the Reds. I'll bring that up later. As the local farmers' leader or as Kolchos leader, you could look pure while working against them. Further, you could get close to information on food questions and the state of food supplies. Look around and get with it!
3. As local farmers' leader, you would also have the opportunity to find out where the real pigs, traitors and Russian collaborators are. That is very important to know. Report it too.
4. You get around in the country. What activity is taking place in Dechentreiter, Koedel, MAN, Siemens, etc.? What is rolling on the rails and roads? What is taking place in the woods? When you have anything special, report it.
5. The man who is giving you this is the man with whom you will be working. When you have something or know something, let him have it. He will forward it along. And when he gives you something to do, take care of it. He knows the reasons behind it.
6. Your friend will need your services from time to time in obtaining observers and legmen of various sorts. Help him out. You have good handwriting. He will also want to work from time to time in your shed or stall. Help him when he does; And no man may know or learn anything regarding the people with whom you are working.
7. No one may be allowed to acquire the slightest knowledge of your activities. Say nothing to your girl friend, etc., absolutely nothing. You know how women are, don't you?

SECRET

SECRET 27 -

Enclosure 16 - 3

Special Assignment for

Dear Franz !

In the deep peace of the post war period you have often shown that you know how to take care of yourself. Therefore I am again confiding in you and am giving you something new and interesting.

We know each other very well, so there is no need for us to tell each other what we will have to go through with the Russians in the long run.

This is sure: "He must be thrown out; it is immaterial how and with what means this is accomplished"!

It is not always said that might makes right. In our present position this is also not true.

You have read the foregoing, and I assure that what we have to do is clear to you:

- a) learn as much as possible and bring it to where help can be procured and
 - b) hurt the Russkies wherever and however you can
 - c) use our own people wherever and however you can!
1. You know your way around in the whole area, you know every path and stick. That is good. You can find your way easily at night or in fog. You know almost everyone and have friends all over.
 2. Further, you were once called a Communist - that affair about the deer and weapons registration. Let it be known that that was actually the case. Perhaps you will be able to go hunting again, and as a licensed - and Communist - hunter you will be able to go wherever you please. My God, you're not so silly as to swallow that! Later, when the situation is turned around, I'll help you to straighten things out. Don't worry.
 3. And when you're a hunter again, we will go poaching together. If a Russky crosses you, then you can blast him. But take care never to be around any place officially when anything happens. You're a Communist, and poachers will be going after you themselves. If things get tough, disappear. Come to me and we'll work it out together.
 4. Nevertheless it would be better to get along with them and not have to take off. Cooperate with the Reds and bring me everything that you can find out about traffic on the roads, info from Augsburg and Donauwoerth, and the railroads.
 5. You will be needed from time to time to bring things here and there, to guard against unwanted snoopers, and other kinds of work.
 6. You can support us by being a good helper, reporter and messenger. In this way you can best help against the Russkies. Later I'll straighten everything out.
 7. This is important, so keep your trap shut! Do a good job.

SECRET

~~SECRET~~

Enclosure 16 - 4

Special Assignment for

Dear Mr. N. :

You are still a young man and - as I assume today as the author - have not yet learned of the East, Asia and Siberia from your own experience.

Have confidence in the advice of your old and true friend, who will perhaps go through this file together with you.

Study the battles of the Lech, Unstrut and Liegnitz; adapt them to the present day situation.

The Russkies are now in our homeland as the result of the world political structure which is no fault of our own. If history is to have any meaning and not sink to the level of a harlot of events, then the Russians must get out; what is the West must remain the West, and we here in western Europe must arrive at a greater unity.

But all this talk doesn't help. There is work to be done.
From today on, the governing principle is: Everything that hurts the Russkies is profitable and good.
Everything which is of benefit to our people is even better.

But the structure of our population will not yet admit of an active resistance in Germany.

We must therefore work with intellect and reason. And we need your spirit, we sons of our fathers far from our homeland, who are endeavoring as much as possible to touch upon and coordinate the events of the war.

We wish to spare our people all evil, and yet meet the enemy wherever we can on our soil.

The basis for our being able to accomplish this is that we be apprised of anything and everything that is happening at home. An uninterrupted exchange must take place between us.

We need your spirit and your youthful drive. You should report to us on Augsburg, Donauwoerth and the surrounding area. I don't have to explain to you in detail what is important and unimportant, or what is of special or lesser interest. You are our eyes where you are.

Where you or take over the direction of the operation is of secondary importance. The main thing is that it will be carried out.

Whether you have decided to use the already chosen radio operator or have found a better one, and whether or not you will need the services of Rupp and/or Franz, and to what extent, are your affairs.

Let the situation develop; don't make decisions too quickly. Wait until you have a reasonable perspective.

Instill a sense of caution and discretion in your operator. Technically he is so well equipped by having his pocket set that no difficulties should arise.

~~SECRET~~

SECRET

Enclosure 16 - 4 (Cont'd)

As for other instructions:

Do it concisely, military style !

Reporting area is under the command of and Mutual good will
in the undertaking, with full individual responsibility.

And now Good Luck and Tallyho in the new job - liberation of People and
Homeland!

SECRET

SECRET

- 30 -

Enclosure 17

Based on Reporting Map

Map Location Reporting Method

The coordinate scale is used to locate all points clearly and unequivocally on all maps.

All official maps are printed with square grids, which cover the entire surface of the map and indicate the method of locus finding by numbers for all German map scales.

For cover purposes we have developed our own system of listing map points by the use of numbers, which is shown on Reporting Map

This ciphering system runs perpendicularly (units right) and horizontally (units up). When citing reference points, always read right and up. Every map scale has its own coordinate scale system, which on official maps is printed on the border.

Directions for the use of coordinate scales have been cut out and pasted below for your information. The coordinate location apparatus which is also attached is of course only usable on a map of the scale 1:300,000 (Enclosure 21 of this folder).

Examples:

The location of	Is recorded as
1. RR bridge over the Lech near Augsburg-Hochzoll	right 13516 up 12080
2. Welden RR station, on air line between Augsburg and Dillingen	right 13312 up 12195
3. Road cutoff to Berg, 2 Km north of Donauwoerth	right 13402 up 12503
4. Highest point of Blankenstein mountain, 7 Km SW of Noerdlingen	right 13148 up 12567
5. Castle in Harburg, 10 Km NW of Donauwoerth	right 13334 up 12562

Try it!! It's quite simple. But it only works with Reporting Map

Directions:

The horizontal portion of the coordinate scale is placed on a horizontal grid line in such a manner that the vertical portion of the scale touches on the point which is to be located. The "right" is then read off from the horizontal scale, using the next left vertical grid line as base point; the "up" is read from the vertical portion of the scale, reading up from the horizontal grid line being used. "Right" is always read first. Location is obtained in meter units.

SECRET

SECRET

- 31 -

Enclosure 18

Reports Writing and Model Reports

1. Report is derived from the German word "melden", that is, to impart a fact. The fact must be depicted as it is known to you. In every case and in every word it must be something on which you would take an oath. Only thus can it have any value and be utilized to our advantage by the people on the outside. The propaganda reports prepared by all parties in the last war are miserable and worthless, and are generally very quickly unmasked.
2. A report is only of use to us when it is:
 - a) true and absolutely accurate,
 - b) understandable and unequivocal and
 - c) received in time, the earlier the better.
3. When you want to report an important fact, proceed as follows:
 - a) put what you want to report in good order.
 - b) write it down in clear and simple words,
 - c) do away with everything that is unimportant and superfluous, until only the pure and unadulterated fact remains
 - d) finally, put yourself in the place of those who will receive your report and check to see that your words will be interpreted exactly as you meant them.
4. To familiarize you with reports and give you a better understanding of what is needed, examples are appended. But remember one thing: these examples are constructed to demonstrate form and method of expression, without regard to content. We cannot predict that intentions known to us today might not end up in fact completely to the contrary.

I. Reports Phrasing Examples

- a) Workers from Ludwigshafen say that a Russian commission was in the IG works, paying particularly attention to inspecting and going through the central electric works. The word in engineering circles is that they are to be dismantled and transported to Merseburg for the construction of a secret weapons factory.
REPORT: It is rumored that IG electric works will be dismantled for use in construction of secret weapons in Merseburg.
- b) A friend, employed in the Land council office, tells you of a considerable increase in work there. All population indexing files have had to be revised. Present jobs, trades learned, former military activity and apparent political attitude have had to be entered for all inhabitants. In order to collate these details quickly, local confidential boards were formed and charged with informant and surveillance functions. This work supposedly is to serve as a working basis for a general mobilization or compulsory military service as well as further oppressive decrees.
REPORT: Land council office employee reports preparation for compulsory military service by bringing population card indexes up to date on former military service and attitude of inhabitants.

SECRET

~~SECRET~~
32

Enclosure 18 (Cont'd)

- c) On your way to work this morning, 15 September, at 0600, you saw four columns of Russian tanks coming off the Autobahn at Mannheim and entering the city by various routes. For exactly a half hour you were able to observe the columns, counting a total of 700 T-34 type tanks. Finally you were told to leave the area, along with other workers, by the military police. While going away, you saw the tanks parking closely together in courtyards and on side streets, after which they were camouflaged with nets. The tanks were also transporting infantry.

REPORT: Definitely determined 15 Sept 0600-0630 700 T-34 arrived Mannheim from Heidelberg after which camouflaged. No observation possible before or after this time.

II. Examples of Specialized Reports

1. Politics and Government

- a) Mayor arrested. KPD minions from mob arbitrarily assigned police powers.
- b) All administration, courts and finance offices still in operation. Commissars from East Germany only in top positions.
- c) All criminals and prisoners released. Insufficient room for former mayors, priests, teachers, SPD members, some private citizens. No opportunity to visit.
- d) All political activity and newspapers forbidden. Communist orientation papers appearing. Publisher Peoples Democratic Upper Command Frankfurt.
- e) Political lead articles speaking of Germany with boundaries of 1507 and partnership Germany-Russia for evolution of the whole world.

2. Economics, Agriculture and Industry

- a) MAN state enterprise after 15 August. New director Russian Semjonew, formerly Stalinez traktorskaja Kiev. Small shop personnel increased to 25,000. Reportedly to manufacture tank chassis without turrets. Working three shifts.
- b) Banks closed after 1 Sept, savings frozen. One state controlled banking central set up in each county to handle all official and private banking and tax questions.
- c) Opel state property with former directors and engineers after 1 Oct. 500 3.5 ton Blitz daily. No sedan construction.
- d) Iron works converted to grenade manufacture. Apparently 28 cm rocket fuses being made in precision instrument sections.
- e) Potato and grain cultivation in Tettwang area collectivized with construction and machine enterprises. Raiffeisen inspiration and leader this move.

3. Propaganda, Handling of Population Enemy Exploitation, etc.

- a) Radio, information bulletins and placards controlled by AOK Frankfurt. Death penalty decreed for listening to enemy broadcasts.
- b) Leading articles infested with Freiherr vom Stein liberation of farmers, Bismarck Russo-German friendship. Suitably pre-written history lessons for teachers after 1 Sept.

~~SECRET~~

SECRET

-33-

- c) No Translivism or Russian world mission themes discernible anywhere up to now. Russo-German cooperation only line identifiable in word and action.
- d) Former property laws unaltered. Clubs coordinated. Pension and old age claims authorized again to previous extent.
- e) Friendly approach to specialists, engineers and teachers easily recognizable. Priests, merchants and industrialists ridiculed as victims of western capitalism. Strong flattery of professional soldiers as intrinsically decent victims of Fascism.
- f) With adequate food supplies, uncurtailed personal and national freedom and friendly approach of enemy, well intentioned populace fears only indiscriminate bombing by West. Beginning of anti-West feeling.
- g) Laying of wreath with Order of Lenin at grave of Woelders for shooting down 110 Western aircraft awakes sympathy for East among German populace.
- h) Professor Mayer, Heidelberg Sulfanilimide researcher, called to Moscow 1 October. Should possibilities be investigated for evacuation?
- i) Return of warship to German Peoples Democracy reason for overall manifestations of sympathy for east. Bombing of residential areas of Cologne resulted in numerous ex-pilots volunteering for the Luftwaffe.

4. Traffic

- a) 72 troop cars all arms transported 25 July from 13694-12490 to 13084-12302. No returning empties.
- b) Road between 13758-12310 and 13499-12316 being widened 14 meters by forced night labor of populace. Bridges being strengthened to support 100 tons.
- c) 50 transport aircraft located 13460-12195 since 1 August. Camouflaged, do not fly. Talk of tank transport aircraft. 2 tanks there, reportedly.
- d) Wooded area approximately 20 Km by 13316-12198 closed to all civilian traffic. Strong to and from convoys since 10 May.
- e) Runways being lengthened 300 meters and strengthened with 30 cm concrete at 13448-11880.
- f) All seaworthy Rhine ships and numerous tugs and small boats have orders to proceed to Holland.

5. Military Reports (Particularly clear and unequivocal)

- a) According to statements of local Communists a section of atomic artillery is to be attached to the 5th Guards Division, located in the area Neuburg-Ingolstadt.
- b) Extended construction at 13392-12145. According to statement of drunken specialist, V-3 launching site ready by 1 November.
- c) 50 superbombers land daily at Landsberg. After 2 day overhaul, they fly west (sic) back to East Siberia.
- d) According to forester, guarded dump for atomic grenades of all calibers located at 13380-12518.
- e) Colleague observed special swimmers training at 13580-12503 for last 3 days. Submerge for long distances with heavy loads of explosives.
- f) All halls and cloisters in Dillingen being cleared. According to doctor's statement, definitely being arranged as contagious disease hospitals. Known spinal meningitis specialists assigned there.

SECRET

SECRET

Enclosure 18 (Cont'd)

- g) At Augsburg 1,000 Siberians located with unknown light gun-carriage weapons and numerous electro-optical devices. Apparently rocket anti-aircraft.
- h) Castle at 13514-12221 occupied by Col. Gen. Schukow and entire staff since 15 September. Further details not yet available.
- i) Since 10 September over 50 trains daily proceeding westward over main rail lines through Donauwoerth, Augsburg and Landsberg; empties returning. Columns of all types of weapons and heavy materiel supplies.
- k) According to rumours, every tenth man and every pre-1938 officer in a mutinous Czech division in Ingolstadt has been shot.

II

- a) Advance party of 1st Guards Mechanized Army in Nymphenburg castle since 1 October. General and troops reportedly underway from southern Russia.
- b) Chief of all Donau crossing points in the area from Dillingen to Passau is located in Neuburg castle. German river construction personnel and materiel depots by all bridges under his command.
- c) At 13427-12362, troops of the 2nd Parachute Div. are making practice jumps with cannon up to 10 cm caliber in the area from Gablingen to Augsburg. 32 aircraft counted, no tank transport machines.
- d) Kaisheim prison has been taken over for use as an interpreting school for Spanish. 400 students there, only Russians.
- e) German driver at Haunstetten aircraft repair works counted 72 MIG fighters in Leipzig, 200 attack type aircraft in Memmingen; 80 bombers are camouflaged at Lechfeld, Fuerstenfeld and Biberg.
- f) Middle Europe tank repair works established at MAN, Augsburg. Still employing all workers. Paralysis of electrical center possible. Causes waste of 500 Kg of munitions.
- g) Infantry and anti-tank construction is being done by forced labor of the population on the eastern bank of the Lech, from the mountains to the river mouth, as well as underbrush obstacles.
- h) Areas on both sides of Dillingen have been declared hospital zones and must be evacuated by the civilian population by 1 November. Wooded area north of the Donau near Donauwoerth supposedly will be recuperation area for light ray wounded.
- k) According to postal official M of Augsburg, the North-South cable south of the Donau is to be dug up and laid openly along some Autobahn stretches in order to strengthen the East-West Russian Communications system.
- l) Artillery observer quartered in German home was cleaning a knapsack radio set with scale of 15-36 with decimal sub-division on sending and receiving parts. Knows only voice radio, no codes.
- m) German mechanic with 2nd Stalin Artillery Div. reported presence by Donauwoerth of special group with some kind of magnetic, light and sound measuring battery, which at the battle near Inn accurately located artillery emplacements and tank concentrations at distances up to 80 Km.
- n) At least 25 companies have been practicing assault landings across the Danube on both sides of Dillingen since 1 Oct. in small rubber boats. Opposite bank covered by smoke bombs. Storm troops carry flamethrowers with 100 meter range. The 1st Rifle Division is practicing street fighting in the ruins of Donauwoerth, supported by bombers but not tanks. Numerous clearly visible rocket signals are being observed.

SECRET

SECRET

- 35 -

Enclosure 18 (Cont'd)

The 1st Czech Division is practicing forest fighting in the woods north of Donauwoerth. Troops armed only with machine pistols and grenades or grenade throwers and bazookas. Going at it heavily. New attack method apparent at tank training area Ried, north of Wertingen. Where formerly infantry transported on tanks, they now advance 2-300 meters ahead of armor.

- o) Kalmuk Division located near Dillingen has only young Communist officers. Very strong discipline. Men tired of war, deserting into the woods. Russian personnel sure of victory.

III

Rifle division, reportedly 12th, in Ingolstadt has given up its rifles and been equipped with captured UN machine pistols and bazookas. Training hard. Officers and soldiers formerly fraternizing with Germans under orders have severed all connections with populace since blowing up of leave train near Friedberg. Former strong prohibition against alcohol apparently lifted. Troops breaking into shops and breweries. Much drunkenness, etc. etc.

Now you have seen for yourself : There is no pattern for a report.

Anything can be important, so report it !!!!

SECRET

~~32-6-2-6945~~

SECRET

MGK-A-35595

Chief, Foreign Division M
Chief of Station, Karlsruhe
Operational

20 December 1951

Evaluation of KIBITZ 15 Materials

1. As we have attempted to illustrate in recent progress reports, the KIBITZ Project now has two distinct parts. The first is a group of Germans carefully recruited on an individual basis by [redacted] and now being organized and trained in teams of three to five members. KIBITZ 15 has been permitted to recruit a second group which he is now arranging into teams and training. We, of course, consider the group recruited by [redacted] to be the most secure and have the higher potential as regards stayability.

2. KIBITZ 15 now spends 95 percent of his time on his group. Due to his ambitious nature and our personnel shortages he passes us up in some areas of the work. One of these is the indoctrination and training of his group and we now find we must constructively criticize and redirect his effort as well as provide him with training materials. He has recently completed, with very little guidance, some instructions for his teams.

3. Attached is a translation of the material sent by KIBITZ 15 to one of his teams. It is submitted for constructive criticism. We should like your comments and particularly those of the authors of Field Notice No. 10-51 and the PASTIME publications mentioned therein. In connection with these publications the most recent ones reaching us have been D-23, 24, 25 and 28. We should especially like to see D-22 titled: Essential Intelligence Targets During the First Phase of Enemy Occupation.

4. Translation of the material was by [redacted] whose comments appear on page A. [redacted]'s comments begin on page B.

5. Should you find that Training and/or the authors of Field Notice No. 10-51 have developed materials intended to be put into agents hands for self study, we would be very interested in receiving distribution.

Distribution:
~~2~~ - FDM w/2 atts.
1 - COS w/1 att.
1 - KOB w/1 att.

my & R

NAZI WAR CRIMES DISCLOSURE ACT

EXEMPTIONS Section 3(b)

- (2)(A) Privacy
- (2)(B) Methods/Sources
- (2)(G) Foreign Relations

SECRET

32-626745

Declassified and Approved for Release
by the Central Intelligence Agency
Date: 2005

SECRET

-A-

1. The style is inconsistent: at some points the author indulges in highflown political dialectics supposedly based on pure logic, at others he waves the flag madly while calling for 'higher, multilateral' etc. union of European peoples. All this is mutually contradictory and thoroughly confusing, but probably designed to appeal to all political shadings among his cohorts.

2. The emphasis of destruction of telltale papers is well taken, in view of the German penchant for reducing everything to writing. The author, on the contrary, seems to have no qualms about keeping voluminous files on much material which could easily be passed by word of mouth.

3. The EEI briefs, while being cited as representing only a general orientation, are tremendously detailed. They also wander quite far afield at some points; (eg, (1) of Enclosure 10 (Transport and Communications): "What ports, moles and docks are being improved, strengthened?). This is rather odd in view of the constant theme of the entire folder, ie, coverage of the central Schwaben-Bayern area.

4. Briefing for steps to be taken in recruitment of radio operators, contact with couriers, etc., is much too vague. No mention is made of passwords, recognition and danger signals, inter-group communication, etc.

5. No A-F, 1-6 or equivalent evaluation system for reports is apparent.

6. No mention is made of safe houses, escape and evasion chains or routes (with exception of brief note on 'helicopter pickup' of Germans who may be of value to the Russians) or air drops.

SECRET

S E C R E T
S E C U R I T Y I N F O R M A T I O N

No. 1808

*Full notified
5 Jan 1952*

OPERATIONAL CLEARANCE

TO: Chief, FDM/C □

Operational Clearance is granted for the use of KIBITZ 15

Limitations: To be used as stated in FDM memo 29 November 1951. This clearance is based upon a ~~(comprehensive investigation)~~ check of ~~(non-derogatory)~~ (negative) files available to headquarters and (non-derogatory) results ~~(negative)~~ of field traces. It should be borne in mind that this clearance is in no way to be construed as a guarantee of subject's bona fides, but merely reflects that disqualifying derogatory information was not developed during the course of the inquiry outlined above. The extent of headquarters checking and the basis for this clearance should be conveyed to the field station concerned.

Jaw
STAFF C/SPB

Date JAN 3 1952

Copy 1 of 2 copies

Attachment: (by hand)
PRQ Part II

S E C R E T

NAZI WAR CRIMES DISCLOSURE ACT

EXEMPTIONS Section 3(b)

- (2)(A) Privacy
(2)(B) Methods/Sources
(2)(G) Foreign Relations

Declassified and Approved for Release
by the Central Intelligence Agency
Date: 2005

AIR

MEMO- 12241

5 January 1952

Chief of Station, Frankfurt

Attn:

Chief, FOM

Operational

KIBITZ 15

Operational clearance No. 1800, effective 3 January 1952, has been granted for the use of Subject as a stay-behind agent. This clearance is based on a negative check of files available to headquarters and non-derogatory results of field traces.

NAZI WAR CRIMES DISCLOSURE ACT

EXEMPTIONS Section 3(b)

(2)(A) Privacy

(2)(B) Methods/Sources

(2)(G) Foreign Relations

Declassified and Approved for Release
by the Central Intelligence Agency
Date: 2005

FORM NO. 35-85
NOV 1951

CLASSIFIED MESSAGE

CENTRAL INTELLIGENCE AGENCY

7 JAN 52

SECRET
SECURITY INFORMATION

IN 26276

ROUTING	
1	
2	
3	
4	
5	
6	
7	
8	

TO: DIRECTOR, CIA
FROM: SR REP FRANKFURT

ROUTINE

NOTION: EE 6

1356Z 7 JAN 52

INFORMATION: P 2, DD/P I & R, FI, FI/OPS, FI/PLANS, FI/STC, FI/RI 2

FRAN 0212

TO: DIR

INFO: SPULL

CITE: SFRAN

OPERATIONAL/CALL

RE: (1) DIR 30525 (OUT 72672)
(2) DIR 32024 (OUT 75069)
(3) SPULL 4648 (IN 23817)

1. SUGGEST FOLLOWING POLICY BE FORMULATED FOR KIBITZ 15 NET, PER REF TWO:

A. IN VIEW OF 'S UNAVAILABILITY WE SHALL IMMEDIATELY
DETAIL TO SURVEY NET.

B. I WILL BRIEF DR. GLOBKE IN GENERAL TERMS
OF NET'S EXISTENCE AND PURPOSE FOR WHICH ORGANIZED AND STATE OUR
INTENTION IS TO KEEP NET ON A HOLDING BASIS. GLOBKE WILL BE ASKED
TO CLEAR THIS WITH CHANCELLOR, AND IF AGREEMENT NOT FORTHCOMING
NET WILL BE DISBANDED. IF NET'S CONTINUANCE AGREED, BFV ALSO WILL
BE NOTIFIED OF NET'S EXISTENCE.

2. FEEL FOREGOING WILL PROVIDE FOR POLITICALLY SAFE CONTINUATION
OF KIBITZ OPERATION. NO IMMEDIATE RISK OF FLAP IN OPERATION FORESEEN.
IF FED GOV DOES NOT AGREE TO NET'S CONTINUANCE, THAT FACT WILL HELP
PHASE-OUT AND DISPOSAL OF AGENTS.

3. RE PARA 4 REF (THREE). REF TO GENERAL HOW INACCURATE;
CORRESPONDENCE IN QUESTION PERTAINS TO AN EXCHANGE BETWEEN KIBITZ 15
AND MAN WHOSE SIGNATURE LOOKED LIKE "DORN", AND CONSTITUTED CRITICISM
OF RIA NK OFFICE AND GERMAN MILITARY PLANNING. THIS ESTABLISHED BY
 AFTER THOROUGH RECHECK OF 15'S FILES SUBSEQUENT TO HIS
REMARK TO

END OF MESSAGE

SECRET
SECURITY INFORMATION

COPY NO.

IT IS FORBIDDEN TO MAKE A COPY OF THIS MESSAGE

(44)

NAZI WAR CRIMES DISCLOSURE ACT

EXEMPTIONS Section 3(b)

- (2)(A) Privacy
- (2)(B) Methods/Sources
- (2)(G) Foreign Relations

Declassified and Approved for Release
by the Central Intelligence Agency
Date: 2005

SECRET

SECRET. NO DISSEM

AIR

MOQW-12B24

15 February 1952

Chief of Station, Frankfurt
Attn:
Chief, EE

KIBITZ 15 Training Manuals

REF: MORA-35595

1. Please excuse our delay in responding to reference memorandum. The reason for this delay has been our desire to pass this document around at headquarters in order to obtain as many reactions as possible.

2. While we are not yet prepared to give you a detailed critique of the K-15 dissertation, we should be inclined to agree tentatively with comments (A) and (B) attached to his document. To put our comments as briefly as possible, while the K-15 document contains some rather basic (and naive) errors, it is in general a rather good set of directions for a particular purpose and for a particular group of indigenous agents.

3. We are having one of the staybehind men in the Training Division study the K-15 manuals in order to prepare a critique which can then be sent to you, and which should contain something more than general comments or criticisms. This critique will be forwarded to you as soon as it is ready.

CHIEF - FOB
19 MAR 52
[Signature]

NAZI WAR CRIMES DISCLOSURE ACT ~~SECRET~~

- EXEMPTIONS Section 3(b)
- (2)(A) Privacy
 - (2)(B) Methods/Sources
 - (2)(G) Foreign Relations

Declassified and Approved for Release
by the Central Intelligence Agency
Date: 2005

OFFICIAL DISPATCH

VIA: Air SPECIFY AIR OR SEA POUCH DISPATCH NO. MEQW-

SECRET
SECURITY INFORMATION
CLASSIFICATION

14 March 1952

TO : Chief of Station, Frankfurt DATE: _____
Attn:

FROM : Chief, EE

SUBJECT: GENERAL -
SPECIFIC: KIBITZ 177

REF: MEFA 6337, MEFA 6338, FRAN 1501

1. A check of headquarter's files reveals no information identifiable with Subject.
2. In reply to FRAN 1501, we shall obtain operational clearance as soon as possible, but you must realize that this is a slow process at best and usually requires three weeks at the very minimum. We wish to cooperate with you to the greatest extent possible in obtaining these clearances (KIBITZ 180 is another example) but in the case of KIBITZ 177 your cable arrived only a few days after PRQs Pts. I & II had been received. We first have to obtain a name check before we can send the PRQs to the appropriate staff for clearance; the staff is furthermore overloaded with such requests.
3. It would help greatly if you could possibly send us the necessary PRQs some time prior to the date when you want the particular subject to have intermediate and advanced W/T training. We note your own lack of administrative help, but your cooperation in this respect will nevertheless be appreciated.

ACC

ECC/mvs

RELEASING OFFICER

ER/SO

WAL STC/

COORDINATING OFFICER

SECRET
CLASSIFICATION

AUTHENTICATING OFFICER

FORM NO. 51-28
JUN 1949

(728)

NAZI WAR CRIMES DISCLOSURE ACT
EXEMPTIONS Section 3(b)
(2)(A) Privacy
(2)(B) Methods/Sources
(2)(G) Foreign Relations

Declassified and Approved for Release
by the Central Intelligence Agency
Date: 2005

MOFA-6400

SECRET
SECURITY INFORMATION

Chief, EE
ATTN: *E* *J*
Chief of Station, Frankfurt

19 March 1952

OPERATIONAL

KIBITZ 15

Ref: MOFA-6399

1. It might not be amiss to point out that I am scheduled to depart for the ZI on 21 April. It is therefore requested that Washington give priority consideration to the plans outlined in the referenced memo with cabled reply so that K-15 and I can work together on interim operational plans for the period of his absence. Further, if duly informed, I might be able to arrange his travel concurrent with mine so as to be on hand to participate in Washington discussions before leaving the agency service.

E
sent EE
20 MAR 52
J

NOTE: MOFA-6399 will follow on 20 March.
Being held up for study by FOB.

EE-2
✓COS-1
FOB

SECRET
SECURITY INFORMATION

NAZI WAR CRIMES DISCLOSURE ACT

EXEMPTIONS Section 3(b)
(2)(A) Privacy
(2)(B) Methods/Sources
(2)(G) Foreign Relations

Declassified and Approved for Release
by the Central Intelligence Agency
Date: *2005*

SECURITY INFORMATION

Air

MOGW- 13270

20 March 1952

Chief of Station, Frankfurt
Attn: FOS [] [] []
Chief, EE

KIBITZ 15 Training Materials

REF: MOGA 35595

1. Our delay in replying to reference memorandum has been caused by our desire to have as many case officers as possible read the KIBITZ 15 training manuals. In fact, the person in charge of the staybehind course, which is being planned for early inauguration, has carefully read these materials and has incorporated certain ideas in his course syllabus.

2. It is our feeling that the comments of [] and [] pretty much cover the reactions of headquarters personnel who have read the K-15 document. These reactions might be summed up more or less as follows:

- a. KIBITZ 15 shows considerable understanding of general stay-behind problems, particularly as regards his questions covering the things which an agent should try to observe and dangers which he should attempt to avoid. Much of the material is, however, directed a bit more toward operational data than is felt commensurate with the short-range nature of the staybehind program.
- b. One of the serious gaps in his material would appear to be the lack of suggestions in the area of tradecraft; this lack is, incidentally, felt by headquarters to be rather generally the case in the training of indigenous agents. In other words, it is our feeling -- perhaps through lack of knowledge of what is being done by the field -- that too much in the tradecraft line is being left in the hands of the individual agent. Granted that the agent must exercise considerable ingenuity and adaptability when faced with trade-craft problems, it is nevertheless true that he should be thoroughly briefed on this aspect of his training. He should have some answers, at least, to such questions as the following: How can enemy DFing be inhibited?

NAZI WAR CRIMES DISCLOSURE ACT

EXEMPTIONS Section 3(b)

(2)(A) Privacy

(2)(B) Methods/Sources

(2)(G) Foreign Relations

Declassified and Approved for Release
by the Central Intelligence Agency

Date: 2005

What are the operational conditions likely to be following enemy occupation? What will the arrangements be for contacts with informants; i.e., couriers, letter drops, etc.? You know much more about such tradecraft matters than we do, but we would nevertheless like to call such things to your attention, since it seems to us that one of the primary questions of an agent would be: How can I keep alive for the longest possible period of time?

- c. KIBITZ 15's political and ideological orientation of his agents appears to be a bit on the "purple" side, which of course brings up the entire question of the kind of motivation which appeals to staybehind agents. Since such motivation can hardly be classed as monetary, it must be either oriented toward the U. S. support of Germany or based on the desire of the average German to keep his country from ultimately falling into the hands of the Russians. Perhaps KIBITZ 15's ultra-nationalistic indoctrination is what is needed to turn the trick; we simply raise the question.
- d. He appears to have a good understanding of basic security considerations; i.e., the burning of papers- the necessity of keeping a close mouth, etc. However, as [] points out, he nevertheless seems to maintain voluminous files. This causes us to ask what ultimately happens to the K-15 files. Does he turn them over to U. S. case officers for safe-keeping? Does he maintain his own files in a secure place? To what extent does he run around the countryside with a briefcase filled with his materials?

3. There is no need to continue a critique of the K-15 paper, since the other points which were discussed here were also covered by [] and []. There are, however, some general questions we have as a result of several recent discussions with the persons preparing the staybehind course:

- a. Have any actual plans been made for the evacuation of KIBITZ 15 and whatever other agents you plan to evacuate, or are these plans still in a rather vague form? We feel that KIBITZ 15 and the other evacuees would feel more secure if they knew that detailed plans have already been made for their evacuation. Also, what plans do you have for evacuating other members of the agents' families?
- b. How do you plan to make crystals and signal plans available to W/T operators? The supposition here is that you plan to give them these materials more or less at the last moment prior to the onset of hostilities. Since there may be no time for this,

SECRET

-3-

have you considered making such things available to some agents as soon as they have completed their training? If they are not secure enough to have these materials now, then they are not secure enough to have them at any time. Presumably BYGONE has some ideas on this matter.

- c. In what detail have arrangements been made for contacts between the agents (informants) and W/T operators during the actual staybehind period? It seems to us that this can hardly be left to chance, and you have doubtless thought this problem out carefully.
 - d. Headquarters personnel are very much impressed by the garden-house arrangement of KIBITZ 10 and suggest similar arrangements for some of the other teams.
 - e. There seems to be some disagreement among various staybehind case officers concerning the type of briefing materials needed in the German language. Would you please describe your needs in this respect in terms which we can meet?
4. It is our impression, as we have said before, that BYGONE support is one of the main remaining problems to be met before the staybehind effort can move ahead more quickly. We hope that Stockdale will bring back some of the answers to such problems.

SECRET

APR 14 1952 *80/c*

OUTGOING CLASSIFIED MESSAGE
CENTRAL INTELLIGENCE AGENCY

*Chow
Board*

SECRET
"SECURITY INFORMATION"

PAGE No.

To: FRANKFURT ROUTINE
FROM: OPERATIONS 10 APR 52
CONFIRMATION: EE (1-4) OUT 68739
INFORMATION: RI (5-6), AD/SO (7), OPS (8), S/C (9-10-11)

Paraphrase Not Required. Handle as SECRET Correspondence per Pars. 51 (1) 60A AR-380-5

WASH 35372

TO: FRANF (ATTN: *E*) *1*) CITE: WASHF
REF: MGFA 6399

AGREE IN PRINCIPLE RE TRIP FOR K-15. HOWEVER HEADQUARTERS SUGGESTS POSTPONEMENT TO LATER DATE. POUCH FOLLOWS.

E *1* ECC
RELEASING OFFICER

WJ
ORIGINATING AND COORDINATING OFFICERS

E *1*
AUTHENTICATING OFFICER

TOD: 1736Z 10 APR 52

SECRET

COPY No.

IT IS FORBIDDEN TO MAKE A COPY OF THIS MESSAGE

16-52325-2 GPO

NAZI WAR CRIMES DISCLOSURE ACT

- EXEMPTIONS Section 3(b)
- (2)(A) Privacy
- (2)(B) Methods/Sources
- (2)(G) Foreign Relations

Declassified and Approved for Release
by the Central Intelligence Agency
Date: *2005*

WASH F

FRAN F 2251

FOB

AC/G ✓

ROUTINE

12 APRIL 1952

RE WASH F 35372

STRONGLY SUGGEST KIBITZ 15 ARRIVE WEEK 21 APRIL. THIS PERMITS
USE IN RECEPTION AND HANDLING. STA WASH 20 APRIL FOR PERIOD TBY TO
HANDLE THIS MATTER BEFORE HOME LEAVE.

NAZI WAR CRIMES DISCLOSURE ACT

EXEMPTIONS Section 3(b)

- (2)(A) Privacy
- (2)(B) Methods/Sources
- (2)(G) Foreign Relations

Declassified and Approved for Release
by the Central Intelligence Agency

Date: 2005

APR 17 1952

OUTGOING CLASSIFIED MESSAGE
CENTRAL INTELLIGENCE AGENCY

15012
"Cleared"
Board
CONFIRMATION
PAGE No.

SECRET

SECURITY INFORMATION

To: FRANKFURT ROUTINE
FROM: OPERATIONS 14 APRIL 52
CONFIRMATION: EE (1-4) OUT 69665
INFORMATION: RI(5-6), AD/SO(7), OPS(8), S/C(9-10-11)

Paraphrase Not Required. Handle as SECRET Correspondence per Para. 51 (1) 60A AR-380-5

WASH 36051

TO: FRANF CITE: WASH F
RE: FRAN 2251 (IN 35103)

REGRET TRIP AND RECEPTION FOR KIBITZ 15 CANNOT BE HANDLED
HERE BEFORE LATE SUMMER OR EARLY FALL. EXPLANATION BEING POUCHED.

RELEASING OFFICER

EC WJ
ORIGINATING AND COORDINATING OFFICERS

AUTHENTICATING OFFICER

TOD: 0218Z 15 APRIL 52

SECRET

COPY No.

IT IS FORBIDDEN TO MAKE A COPY OF THIS MESSAGE

16-52125-2 GPO

NAZI WAR CRIMES DISCLOSURE ACT

- EXEMPTIONS Section 3(b)
- (2)(A) Privacy
- (2)(B) Methods/Sources
- (2)(G) Foreign Relations

Declassified and Approved for Release
by the Central Intelligence Agency
Date: 2003

SECRET
SECURITY INFORMATION

Air

MOGW-

Chief of Station, Frankfurt
Attn: Chief, EE

14 April 1952

KIBITZ Plans and Training

REF: WIPA 6399

1. This dispatch concerns primarily the suggestion made in reference memorandum that KIBITZ 15 be sent to Washington for purposes of training, further orientation, etc.
2. Consideration of such a trip should include both the considerable benefit which we would be able to derive from KIBITZ 15's comprehensive knowledge of field problems and the additional knowledge which he should obtain from training and briefing received here. The opportunity for him to improve and further develop his training manuals is also an important factor.
3. We readily acknowledge the fact that KIBITZ 15 can be of great service to numerous persons here. We do not, however, wish to bring him here until there is further crystallization of several aspects of staybehind planning, not only with reference to Germany, but in general. We have alluded from time to time to the planning here for a comprehensive staybehind course. Present plans indicate that this course will be given a dry run around the middle of May. It will be under the direction of [redacted], who will have three assistants under his supervision. Currently [redacted] and others are conducting a detailed program concerned with the debriefing of all personnel here who are in any way charged with staybehind responsibilities. This procedure is preliminary to the actual inauguration of the course. Following the debriefing the afore-mentioned dry run (in the form of a seminar) will take place and will be attended by most of the people who have taken part in the debriefing sessions. Following the dry run, [redacted] would like to run through at least two terms of the staybehind course before he will feel competent to judge what aspects of the course should be retained, deleted, strengthened, etc.
4. It is the feeling here, in view of the above situation, that an immediate trip here by K-15 would be of dubious value to him. We therefore propose that his trip be postponed until the course and various training materials are well in hand.

NAZI WAR CRIMES DISCLOSURE ACT

EXEMPTIONS Section 3(b)
(2)(A) Privacy
(2)(B) Methods/Sources
(2)(G) Foreign Relations

SECRET
Declassified and Approved for Release
by the Central Intelligence Agency
Date: 2005

SECRET

-8-

It is assumed that this will involve several months, so that the trip could well be planned for sometime early in the fall of the year.

5. Thus, while we cannot say categorically just when the trip will be possible, we are heartily in accord with your suggestion concerning its value. We will do our utmost to work it out when the proper time arrives.

6. We have had no opportunity to examine the K-15 training manuals in more than a cursory fashion. We will, however, give some time to them and will make certain that Barber and others have an opportunity to study them carefully, so that they can be reviewed and constructively criticized.

7. We believe that the possible employment of K-15 as a contract agent should be settled either during or after the period of his visit here.

[]

SECRET

MOFA-6481

**SECRET
SECURITY INFORMATION**

25 April 1952

Chief, GI
ATTN: Chief of Station, Frankfurt

APR 12 3 12 PM '52

OPERATIONAL WALTER KOPP
MOFA-6480 *did KIBITZ*

1. The source of the allegations made in reference is Walter KOPP who lives in the town referred to in subject memorandum.
2. In connection with paragraph 5, MOFA-6480, it is requested that if the CIC investigation points in any way to KOPP or if the CIC desires to contact KOPP on this case, this office should be informed immediately. If possible, CIC should not contact him personally until we have been notified.
3. If it is at all possible, it is desired that KOPP be left out of this case completely. In no case should CIC be told that he is the source of the allegations against the subjects of MOFA-6480.

HOS

RECEIVED

APR 11 1 25 PM '52

CLS-1
COS-1
EE-1
POB-2
A/c

CS COPY

**SECRET
SECURITY INFORMATION**

AN RB
AB ✓
IN D
ES
EX
RES NED
FI
IC/E/R

NAZI WAR CRIMES DISCLOSURE ACT

IRI COPY

- EXEMPTIONS Section 3(b)
- (2) (A) Privacy
 - (2) (B) Methods/Sources
 - (2) (G) Foreign Relations

Declassified and Approved for Release
by the Central Intelligence Agency
Date: 2005

ECC 217 22 11 25 52

MGFA-6482

SECRET
SECURITY INFORMATION

Chief, EE
ATTN: []
Chief of Station, Frankfurt

25 April 1952

OPERATIONAL

KIBITZ 15

Ref: MGKW-7976, 20 Feb 1951
MGKA-36248, 20 Dec 1951

1. Paragraph 1, of MGKW-7976, refers to a memo of a staff member reporting alleged (1947) anti-American sentiments of KIBITZ-15 and a 1948 altercation in which KIBITZ-15 and some of his former comrades-in-arms were involved. KIBITZ-15 has explained this altercation by saying that it was caused by an "American informant" who, in a heated argument with several "highly decorated former German soldiers" (including KIBITZ-15) called the latter, war criminals. The so-called American informant refused to apologize and was then set upon by the ex-soldiers and beaten. The whole argument, according to KIBITZ 15, started with an intensive discussion over the "terrible" features of the Morgenthau ideals of the American Occupation. The conversation evidently became more and more anti-American and the "American informant" (ostensibly Kirner of MGKW-7976) defended the American viewpoint for which he was beaten up. Generally, KIBITZ-15's story coincides with that of referenced memo although we have had no opportunity to go into the letter to Switzerland part, nor into the Kirner-KIBITZ 15 court proceedings without tipping our hand too much.

2. From what can be discerned here, [] had questioned KIBITZ-15 on this matter on several occasions. Finally, KIBITZ-15 put in a report on it which emphasized not the fisticuffs with Kirner, but the fact that the occasion of the fight was the first and only time that he talked to a man who is allegedly a communist agent with a specific mission of "undermining the West".

3. The alleged communist agent and his mistress are the subjects of MGKA-36248, 20 December 1951. They live in KIBITZ-15's hometown. File checks with COS, ELS and CLS are negative. Because of the fact that KIBITZ-15's hometown is such a small dorf, it is believed that a full scale investigation might possibly injure him and thus our operation. Therefore, we are going to notify CLS of the allegation against the subjects of MGKA-36248 and have them ask for a very discreet investigation. Results of the EE trace on these two alleged communist agents // would also be appreciated.

EE-2
COS-1
BOB-2

SECRET
SECURITY INFORMATION

COPY

NAZI WAR CRIMES DISCLOSURE ACT

- EXEMPTIONS Section 3(b)
- (2)(A) Privacy
 - (2)(B) Methods/Sources
 - (2)(G) Foreign Relations

Declassified and Approved for Release
by the Central Intelligence Agency
Date: 2005

SECRET
SECURITY INFORMATION

- 2 -

4. Your MOKW-7976, paragraph 2, stated that an attempt would be made to obtain from the Department of the Army, a copy, if available, of KIBITZ-15's Wehrmacht "201 file". From our records it appears that such a copy was never received here. As mentioned in your paragraph 2, of reference, there are some inconsistencies in KIBITZ-15's military record. Also, exact details of his specific military assignments during his 13-year military career would be a great aid in our assessment of his capabilities and potentialities in regard to his part in the KIBITZ Project. If you could forward a copy of KIBITZ-15's Wehrmacht "201 file" as soon as possible, it would be greatly appreciated. //

AKZ

[

]

SECRET
SECURITY INFORMATION

~~32-63-8273~~

SECRET

Air

SECURITY INFORMATION

MOGW-14165

12 Mar 1952

Chief of Station, Frankfurt
Attn:
Chief, EE

KIBITZ 15

REF: MOFA-6482

1. We are very interested in the fact that is probing into the various escapades, security aspects and basic motivations of KIBITZ 15. To make a long story short, there is ample evidence in dispatches both to and from the field that KIBITZ 15, while an astute and able organizer, is far from lily-white in some other respects. We can only hope that his current value to us and his apparent devotion to our program will prevent him from running off with his own "little Zipper" unit when the time comes for the establishment of German sovereignty, a German army, etc. Without knowing the man, it has sometimes been difficult for us to believe that an "unreconstructed Nazi" with a typical Wehrmacht background could suddenly become an ardent pro-American pan-European gentleman of parts. Where there's life there's hope, however. In any case, we are glad that you are investigating the events described in MOGW-7976.

2. With respect to Para. 4 of reference memorandum, reviewed K-15's Wehrmacht 201 dossier on 9 March 1951. This review revealed little not already known about K-15, but you might be interested in the following statement from the 201 file: "He (K-15) was regarded by his superiors as a very good soldier, a hard worker, and an enthusiastic National Socialist. He is described as somewhat overbearing and conceited in one report. The report of the General Staff School in Berlin states that KIBITZ 15 would be a good leader, but that he lacks the ability to grasp and fully understand the whole situation. KIBITZ 15 was last reported a major on 26 September 1944."

3. We note that you desire fuller information than the above; thus we will again request the K-15 201 file and send you detailed information.

NAZI WAR CRIMES DISCLOSURE ACT

EXEMPTIONS Section 3(b)

- (2)(A) Privacy
(2)(B) Methods/Sources
(2)(G) Foreign Relations

Declassified and Approved for Release
by the Central Intelligence Agency
Date: 2005

SECRET

-2-

4. We will also send you a report on the alleged communist agent and his mistress (MGKA-36884) as soon as a headquarters check can be completed.

L

1

SECRET

"K" Library/ C 3

15 May 1952

EE/SO/G/C 1

Request for Wehrmacht 201 Files

Herewith is biographical information concerning the following persons on whom the above files are requested:

KOPP, Walter - Born 21 March 1913; lives in Bittenwiesen bei Augsburg; served in Wehrmacht from 1 April 1932 to 27 May 1945 when he turned himself in as an American POW, arrived at Neu-Ulm camp from which he was released on 29 June 1945. Last rank held that of Colonel; received this rank 1 January 1945.

BUCHHORN, Otto - Born 3 February 1914 in Bad Canstatt; lives in Oppenweiler über Backnang; entered military service in 1934, attended infantry school in 1935, commissioned in 1937, served as adjutant (lieutenant) in Combat Engineers Battalion and later company commander (captain). Served later as battalion commander in Ukraine and Caucasus campaigns. Last grade - major. Served in military until 1945.

EE/SO/G/EGC:j1

NAZI WAR CRIMES DISCLOSURE ACT

Declassified and Approved for Release
by the Central Intelligence Agency
Date: 2005

EXEMPTIONS Section 3(b)
(2)(A) Privacy
(2)(B) Methods/Sources
(2)(G) Foreign Relations

SECRET

OFFICIAL DISPATCH

VIA: Air
SPECIFY AIR OR SEA POUCH

DISPATCH NO. MGQW-14932

~~SECRET~~
Security Information
CLASSIFICATION

TO : Chief of Station, Frankfurt
Attn:

FROM : Chief, EE

DATE: 7 July 1952

AN	<input checked="" type="checkbox"/>
AB	<input checked="" type="checkbox"/>
IN	<input checked="" type="checkbox"/>
PS	<input type="checkbox"/>
BR	<input type="checkbox"/>
DE	<input type="checkbox"/>
FI	<input type="checkbox"/>

SUBJECT: GENERAL.

SPECIFIC KIBITZ 15 and 150 - Wehrmacht 201 Files

REF: MGFA-6483

1. Please excuse our delay in obtaining the requested information from the above-listed files. Unfortunately these files are somewhat difficult to obtain and the procedure is a slow one.

2. Rather than make photostatic copies of this information - which would have involved an even longer delay - we have copied all of the relevant information as follows:

KIBITZ 15

Listed in the 201 file as born 21/3/13 in Alsenz, Rheinpfalz.

Service Career: (Dienstlaufbahn) - entered service on 15 July 1933 as Pionier; became Gefreiter on 1 October 1933; Unteroffizier on 24 December 1933; Fähnrich on 1 September 1934; Oberfähnrich on 17 December 1934; Leutnant on 1 March 1935; Oberleutnant on 31 April 1938; Major on 10 June 1943. Highest rank held: Major. Served until 26 February 1945.

Commands Held: From the Beurteilungsnotizen für Offiziere,
5th Jaeger-Division, 26 September 1944:
25/8/39 to 18/12/41, Kp. Chef 3. (mot) Pl.5
19/12/41 to 5/3/42, Kdr. Pl. Btl. 123
6/3/42 to 31/5/42, zur Gen. St.-Vorausb. (14 Pz. Korps) kdt.
1/6/42 to 9/8/42, Kriegsakademie Berlin
10/8/42 to 3/9/42, Fuehr. Res. OKH
4/9/42 to 4/9/43, Kdr. Pl. Btl. 369 (Kroat)
5/9/43 to 31/1/44, Gen. d. Pl. und Fest. beim Gen. St. d. H.,
Gen. z. b. V.

RELEASING OFFICER
EE/BC

COORDINATING OFFICER

AUTHENTICATING OFFICER
2/026/500

~~SECRET~~
Security Information
CS COPY
CLASSIFICATION

FORM NO. 51-29
JUN 1949

(788)

NAZI WAR CRIMES DISCLOSURE ACT

EXEMPTIONS Section 3(b)

- (2)(A) Privacy
- (2)(B) Methods/Sources
- (2)(G) Foreign Relations

Declassified and Approved for Release
by the Central Intelligence Agency
Date: 2005

(27/5 to 26/6/44, Fuehrer Jaeger Regiment 75;
13/8 to 21/9/44 Fuehrer Jaeger Regiment 56.)

Estimates: Definite leadership personality with open, honest character. Fresh, always optimistic manner. Confident and full of initiative, great will power. Enthusiastic National Socialist of great conviction. Courageous when faced with the enemy and firm in any crisis. Energetic and ambitious. As regimental commander he had sound judgment in the most difficult situations, quick judgment powers, and tenacious will. Tactically and technically very well schooled. Intellectually a many-sided person; physically robust.

Strong points: Outstanding and passionate troop leader. His strength lies definitely in the field of practical troop leadership. As a leader in battle, as a result of his willpower, his always confident bearing, and his inner strength, he was able to undertake the most difficult assignments. Ambitious type. Very much of a daredevil.

Weak points: Because of his marked, often drastic manner of expression, he appears very confident, but without being overbearing.

All other estimates agree in essence with the above, and all speak of his enthusiasm for the Nazi cause, as well as for his ability to influence others by this enthusiasm.

Other Comment: Very well-equipped for training as General Staff Officer.

KIBITZ 150

Listed as born 3/2/14 in Ulm, Wuerttemberg.

Service Career: Dienstlaufbahn - Entered service as Pionier on 1 November 1934; became Gefreiter on 1 July 1935; Unteroffizier on 18 December 1935; Faehnrich on 29 June 1936; Oberfaehnrich on 21 October 1936; Leutnant on 20 April 1937; Oberleutnant on 31 August 1939; Hauptmann on 16 March 1942; Major on 20 April 1943. Served until 1 June 1944.

Commands Held:

28/8/39 to 1/12/39, P1. Btl. 5, Adjutant
2/12/39 to 1/10/40, 2nd P1. Btl. 5, Kp. Chef
2/10/40 to 28/2/42, 2nd P1. Btl. 125, Kp. Chef
1/3/42 to 18/3/44, P1. Btl. 125, Kommander

SECRET

-3-

Estimate as an Officer: Even, open and honest character. Always willing, able officer. Modest and withdrawn toward his superiors; rather withdrawn personality. Good National Socialist. In face of enemy has proven his courage many times. Is a careful and excellent leader of his batallion. His strength lies more in technical and Pioneer-tactical fields. Well equipped intellectually; physically energetic.

Strong points: Great technical know-how and good tactical understanding.

Weak points: Very calm with little temperament. But above average.

Other comments: Well equipped for career as General Staff Officer. All comments indicated that he was a good Nazi.

General Estimate: (From recommendation for promotion to rank of Major) Earnest officer, motivated by high soldierly and National Socialist ideals. Has faced the enemy often and well. Clever tactician and technically a well-trained Pioneer Commander, who has led his batallion since 15 April 1942 extremely well. Showed up well as early as the campaign into France and was awarded the Iron Cross I and II. Since the beginning of the campaign into Russia was at the front. Captain Buchhorn fills all qualifications and is well suited for the rank of Major. (By the Division Commander.)

DA2

F.C.C.]

OT # 1. VON

ECC/jl

WIDAEDI
WIDAEDI
NOI SB 11 18 44

WIDAEDI
WIDAEDI
NOI SB 11 18 44

8500

SECRET
SECURITY INFORMATION

4. Coincident with pressuring KIBITZ-15 for PRQs on W/T operators, we have picked out those KIBITZ-15ers who were earmarked by KIBITZ-15 to be team leaders as those next in line to hand in their PRQs. This phase of our tightening up the reins on the operation has only been going about a month. It has brought some results, but nothing that can be elaborated on here for KIBITZ-15 is in the midst of reshuffling some of the teams because of normal attrition (dropped agents, changing of residence of individual agents, lack of time with others, etc.). Right along with the team leader question, of course, goes the problem of formation of the individual teams. It is hoped that the results of this shuffle will be available within the next ten days for forwarding to you.

5. In the meantime, KIBITZ-15 has been pumped continuously for identification of his various contacts and alter ego's who are co-operating in this adventure. The main results of this have been a number of PRQs which have been sent to you in the last several weeks and some additional names. However, for the sake of clarity and for easier reading, the following listing will bring your files as up-to-date as ours are on just who is who in the KIBITZ-15 show.

6. The letters in parenthesis to the left of the KIBITZ number are keyed to MGFA-6655 which gives true names and addresses, when known, of the newly identified sub-agents in the KIBITZ-15 complex. The phrase "under development" after a KIBITZ number means that KIBITZ-15 has not yet actually recruited the individual yet. Note: Under the relationship that was set up with the original recruitment of KIBITZ-15, he (KIBITZ-15) spots, contacts and actually pops the \$64 question to the candidates, then gives us a PRQ. This is the main reason why we have from the first, continually pressed KIBITZ-15 for PRQs and have been quite adamant in the "ground rule" that his KIBITZers do not enter a safehouse or begin W/T or other training (even the most rudimentary) from staff personnel without at least a Provisional Clearance. It has been tough sledding on occasions, but we think the old boy has the general idea now that we mean what we say.

- 101 through 107 -- under development
- 110 -- under development
- 111 -- under development
- 119 -- under development
- (a) 120 -- ex-1st lieutenant; scheduled to be Wuerzburg Team Leader.
- (b) 125 -- ex-major, now Stadt baumeister.
- (c) 126 -- ex-Unteroffizier; scheduled to be Team Leader in Goepingen area.
- (d) 131 -- ex-Hauptmann; chinaware salesman
- 132 -- PRQ I in MGFA-6644; II in MGFA-6645; scheduled to be Team Leader, Karlsruhe
- 136 -- PRQ I in MGFA-6650; II in MGFA-6651; scheduled to be Team Leader and W/T operator in Ludwigshaven.
- 137 -- PRQ I in MGFA-6511; II in MGFA-6652; scheduled to be Team Leader and W/T operator in Gauersheim area.
- (e) 138 -- ex-1st lieutenant; Bahnmeister, scheduled to be Team Leader in Railroad Observation Team in Pfalz.
- (f) 141 -- nurse, Bad Toelz; under development by KIBITZ-150.
- 142 through 144 -- under development by KIBITZ-150 and KIBITZ-

SECRET

SECRET
SECURITY INFORMATION

- 137.
- 145 -- potential W/T operator; now dropped, see MGFA-6656
158 -- potential W/T operator; now dropped, see MGFA-6656
162 -- " " " " " " " "
165 -- " " " " " " " "
168 -- " " " " " " " "
- ✓(g) 172 -- ex-Feldwebel, under development
173 -- PRQ I in MGKA-35238; II in MGFA-6488; scheduled to be W/T operator in a Stuttgart Team.
- ✓(h) 174 -- member of team and family, same surname, of KIBITZ-109 in Munich; under development
175 -- under development for KIBITZ-109's team
176 -- under development for KIBITZ-109's team as W/T operator
178 -- potential W/T operator; now dropped, see MGFA-6656
179 -- under development by KIBITZ-138
- ✓(i) 181 -- under development
183 -- under development by KIBITZ-136
184 -- under development by KIBITZ-136
185 -- potential W/T operator; now dropped, see MGFA-6656
186 -- under development by KIBITZ-137
- ✓(j) 187 -- under development; scheduled to be W/T operator
✓(k) 188 -- under development; scheduled to be W/T operator
✓(l) 189 -- ex-SS Gruppenfuehrer; under development
193 through 196 -- under development
197 -- potential W/T operator; now dropped, see MGFA-6663
198 -- PRQ I in MGFA-6583; II in MGFA-6388, FOC WASH F 12186; Scheduled to be W/T operator. *not here*
199 -- PRQ I in MGFA-6593; II in ~~MGFA-6640~~; scheduled to be W/T operator and Team Leader
200 -- wife of KIBITZ-199; PRQ I in MGFA-6594; II in MGFA-~~6640~~; *here* scheduled to be member of husband's team and possibly alternate W/T operator
- 201 -- through 213 -- under development
- ✓(m) 214 -- woman in Fuerth; acts as temporary cut-out for KIBITZ-15
215 through 217 -- under development *not here*
218 -- PRQ I in MGFA-6514; II in MGFA-6653; scheduled to be W/T operator
219 -- under development
- ✓(n) 220 -- ex-lieutenant colonel; acts as temporary cut-out for KIBITZ-15; under development
221 -- PRQ I in MGFA-6648; scheduled to be W/T operator
222 through 224 -- under development
- ✓(o) 225 -- part-time courier for KIBITZ-15; under development
226 through 230 -- under development in Stuttgart
231 through 236 -- under development *not here*
- ✓(p) 237 -- wife of KIBITZ-137; PRQ I in MGFA-6646; scheduled to be member of husband's Team and possibly W/T operator

SECRET

VIA: AIR Pouch
(SPECIFY AIR OR SEA POUCH)

DISPATCH NO. MGFA-6663

SECRET
SECURITY INFORMATION
CLASSIFICATION

TO : Chief, WR
 ATTN: E
 FROM : Chief of Station, Frankfurt cl/hw

DATE: <u>7 August 1952</u>	Checked
For info end file	<input checked="" type="checkbox"/>
For para. [] by pouch	
For para. [] by radio	
For para. [] by pouch	

SUBJECT: GENERAL—Operational

SPECIFIC KIBITZ-197

REF: MGFA-6664 Hans Reinhold WILHELM

- Reference gives true name and identity of KIBITZ-197.
- As noted in par 4, of MGFA-6656, subject was dropped as a potential KIBITZ W/T operator as of late July 1952. Subject was never name traced although we have a PRQ I and II on him, that were made out by KIBITZ, which will be forwarded under separate cover.
- We were first told of KIBITZ-197 by KIBITZ-15 some two and one half months ago. K-15 emphasized what a good man he was and that he had been a top-flight W/T man during the war. In addition, his present position, emphasized KIBITZ-15, of a Beamter in the Land Baden-Wuerttemberg government should make him an asset to our operation. We agreed that he looked promising, but hastened to add that a PRQ would have to be turned in on him before we could set a training date. KIBITZ-15 about mid-June said that KIBITZ-197 was taking some leave about the middle of July and would be available for training. Again the PRQ question, for none had been forthcoming. K-15 finally got around to turning in a PRQ on the man on 3 July, saying again that he was ready for training in mid-July. I said no, that we would have to wait for a clearance.
- On 11 July KIBITZ-15 again brought up the subject of KIBITZ-197 going into training, the following week. I said no, that I did not have my checks on him made and that all we could would be to have one of our US W/T instructors assess him -- a two hour session at the most. KIBITZ-15 saw that I was serious and agreed, saying that we would tell KIBITZ-197 that he could not go into training because there was no instructor available. KIBITZ-15 put all the arrangements from his side of the picture for this assessment meeting in KIBITZ-150's hands. I had take one of our W/T instructors, to

Distribution:
 2-EE
 2-COS
 1-FHB
 2-KIBITZ

AN	<input checked="" type="checkbox"/>
AB	<input checked="" type="checkbox"/>
IN	<input type="checkbox"/>
PS	<input type="checkbox"/>
BX	<input type="checkbox"/>
DES	<input type="checkbox"/>
NFD	<input type="checkbox"/>
FI	<input type="checkbox"/>

SECRET
SECURITY INFORMATION
CLASSIFICATION

FORM NO. 51-28A
 MAR. 1949

NAZI WAR CRIMES DISCLOSURE ACT

- EXEMPTIONS Section 3(b)
- (2)(A) Privacy
 - (2)(B) Methods/Sources
 - (2)(G) Foreign Relations

Declassified and Approved for Release
 by the Central Intelligence Agency
 Date: 2005

-2-
SECRET
SECURITY INFORMATION

the meeting place -- the Hotel Krone, Bretten, Bruchsal-Mullacher. They were told that KIBITZ-197 was to be assessed only.

5. On arrival at the meeting place, [] and [] met KIBITZ-150 and were introduced to KIBITZ-197. Immediately the air became quite tense, for it was apparent from the beginning that KIBITZ-15 had purposely and intentionally neglected to tell KIBITZ-150 that the meeting was for an assessment only. KIBITZ-197 was all ready to go into a two week training session in a safe house; had told his family and friends that he would be on "vacation for two weeks and could not be contacted", etc. Everything was quite strained. KIBITZ-150 was especially on the spot for it was apparent that he had recruited KIBITZ-197. Anyway the man was assessed -- and he would have made a damn fine operator; he had 10 W.P.M. after, according to him, seven years without touching a key.

6. Needless to say, KIBITZ-197 was quite disturbed and has said that he would have nothing more to do with our operation, (and maybe KIBITZ-150 and KIBITZ-15, too??) Thus the fact is that he was not actually dropped, but that he severed relations of his own accord.

7. KIBITZ-150 was quite displeased about the whole affair and after discussions in private [] and [], appeared to be considerably browned off at KIBITZ-15 and not so much at us.

8. On 31 July when I saw KIBITZ-15 again (he had been on leave in Switzerland from 16-28 July, visiting his wife's relatives in Lugano) we got around to discussing the KIBITZ-197 affair and he began to perspire on his upper lip. (He does this when ever he gets excited or when is about to tell an untruth.) KIBITZ-15 said that KIBITZ-197 did not want to be in the operation any more and that it was a real shame for he was such a good man. He then, before I could get in my two cents' worth, said that [] had not told KIBITZ-197 that there was no instructor available to train him or that the instructor scheduled to train him was sick. In other words, the blame was passed right back to me. I said that [] had said there was no instructor available and that this was a shock to KIBITZ-197 and KIBITZ-150, who should have been briefed previously by KIBITZ-15. KIBITZ-15 then muttered and grumbled to himself, sweated some more on the upper lip and went on to another subject. I let it go at that, saying that it was too bad to lose a good man but that we must get PRQs in time.

9. Actually KIBITZ-15 had tried to force me into accepting KIBITZ-197 for training without a security check. If he would be given half a chance, he would run away with the entire show. If he is pushed too much, he is liable to balk completely and the net that he has set up has many good points. We have done our best to get it under control during the past four months and do believe that some progress has been made. However, there are several things that are worrying. They shall not be gone into in this report which is only a typical incident. An overall assessment of the KIBITZ-15 show is in draft stage, however, and we hope to get it out in the next week.

10. One of the reasons I refused to let KIBITZ-197 go into training was the way KIBITZ-15 turned in his PRQ. After, as noted above, the two month long discussion of the "great KIBITZ-197", his PRQ was finally turned over on 3 July 52 to [] at a meeting he had with KIBITZ-15 while I was away on leave.

SECRET

-3-
SECRET
SECURITY INFORMATION

[] says that KIBITZ-15 began discussing the training schedule and KIBITZ-197. When [] asked where KIBITZ-197's PRQ was, KIBITZ-15 sat down at a typewriter and pounded it out right then and there -- sans notes, and included birth-dates, etc. [] didn't say anything then but mentioned it when we looked at the PRQ. With the fact that KIBITZ-15 wanted in the worst way to get the man into training we decided to do a little checking. Our suspicions seemed at first unfounded for we did find that a man by KIBITZ-197's name lives at the address given in Stuttgart. We did not get much more of a check made before the assessment. [] because of sickness, could not make the assessment meeting as planned and [] did not see the PRQ before meeting KIBITZ-197. But [] did and the PRQ said that KIBITZ-197 was 27 years old while [] says the man he assessed would be close to 40. We are still checking and will report results, if any, when received.

11. In the meantime, we have just lost a potential W/T operator out of the KIBITZ-15 show in which we appear to have enough to keep us plenty busy any how. Security-wise I do not think we have any worries about KIBITZ-197 for he did not know enough to do us any harm. KIBITZ-15 and KIBITZ-150 have just told him the bare facts that this is a German anti-Commie underground organization that is working with the Americans. That I do not think will do us any harm. He saw no classified equipment during his assessment. He does not know (as far as we can tell) the location of safe houses, or the true names of Staff Personnel.

[]
[]
JOM

SECRET

[] []

AIR

SECRET

MGFA-6657

SECURITY INFORMATION

20 August 1952

ATTN: Chief. EE
COM, Frankfurt

Operational

Identification of ~~Dropped Agents~~

MGFA 6656

dda

REF: MGFA-6656

The following are the true names and addresses, when known, of agents who have been dropped. Numbers in parenthesis are keyed to agent cryptonyms which are given in reference. Reference also explains reason for dropping and detailed operational data, if any, known by each dropped agent.

- (1) - Paul Ring, Rolladenfabrik, Kaiserslautern, Schubertstr.
- (2) - Herbert Hoegler, Ilbesheim
- (3) - Fritz Pfoertner, Alzey bei Praempeler
- (4) - Studentenrat Keim, Alzey
- (5) - fnu Kraus, Lauterbach
- (6) - Heinz Schaefer

DIST:
2 - EE
1 - COM
1 - FHB
1 - KIBITZ

NAZI WAR CRIMES DISCLOSURE ACT

Declassified and Approved for Release
by the Central Intelligence Agency

SECRET

Date: *2005*

- EXEMPTIONS Section 3(b)
- (2)(A) Privacy
 - (2)(B) Methods/Sources
 - (2)(G) Foreign Relations

AIR

SECRET
SECURITY INFORMATION

MGFA-6656

Chief, EE
ATTN:

26 August 1952

CASE

DCOM, Frankfurt

Operational

Dropping of some Agents in KIBITZ-15 Show

Ref: MGFA-6657

1. Our difficulties with KIBITZ-15 over the sub-
mission of PRQs and his quite negative view of the same
were detailed in MGFA-6501. Coincident with the laying
down of the "ground rule" in our relationship with
KIBITZ-15, that PRQ I and II were required on all his
sub-agents, we began a campaign to have him indicate to us which of his KIBITZers
were no longer considered to be active agents or even potential agents. This
developed into quite a struggle for the old "colonel" hates to see his regiment
decimated. In our approach to this problem we necessarily had to keep from going
too far in our demands so that we would not alienate KIBITZ-15. But, all in all,
we believe that some progress has been made, for this past week we got from him a
list of seven embryo W/T operators who are dropped from active participation in
the project as of this date.

2. The numbers in parenthesis to the left of the KIBITZ number are keyed to
a list of true names and addresses which is given in MGFA-6657.

3. The following are sub-agents of KIBITZ-15 who are considered dropped as
of this date. The KIBITZ numbers given will be placed in our dead file and not
issued to any other agent recruited in the KIBITZ-15 net:

145 - No record in our files; agent was only under development by KIBITZ-15.

Security Factors: Subject never met staff personnel; has never been
in safehouse; has never seen classified W/T
equipment.

W/T Training: Spent 8 hours training time with K-171.

Equipment: Tone oscillator, instructograph, keys, headset.

Reason for Dropping: No time; afraid.

Distribution:

2 - EE
2 - DCOM
1 - PHB
2 - KIBITZ

- 1 -

SECRET
SECURITY INFORMATION

NAZI WAR CRIMES DISCLOSURE ACT
EXEMPTIONS Section 3(b)

(2)(A) Privacy
(2)(B) Methods/Sources
(2)(G) Foreign Relations

Declassified and Approved for Release
by the Central Intelligence Agency
Date: 2005

SECRET
SECURITY INFORMATION

- 2 -

(1)158 - Ex-lieutenant; Ref: MGKW-11941, MGKA-30733

Security Factors: Subject never met staff personnel; has never been in safehouse; has never seen classified W/T equipment.

W/T Training: Several hours with K-171.

Equipment: Tone oscillator, instructograph, keys and headsets with K-171.

Reason for Dropping: No time.

(2)162 - Farmer; at one time scheduled to be W/T operator for K-137's team; never PRQ'd or traced.

Security Factors: Subject never met staff personnel; has never been in safehouse; has never seen classified equipment.

W/T Training: None by staff or K-171.

Reason for Dropping: No time.

(3)165 - Ex-Oberfeldwebel; scheduled to be W/T operator in K-166's team; never PRQ'd or traced.

Security Factors: Subject has never met staff personnel; has never been in safehouses; has never seen classified W/T equipment.

W/T Training: None by staff or K-171.

Reason for Dropping: No time now; he may be recontacted at a later date.

(4)168 - Ex-Wehrmacht ~~Cosmo~~ Officer; scheduled to be W/T operator on K-166's team; never PRQ'd; trace requested MGKA-28454 with negative results COS, CLS; for EE comments see MGKW-8920.

Security Factors: Subject has never met staff personnel; has never been in safehouse; has never seen classified W/T equipment

W/T Training: None by staff or K-171.

Reason for Dropping: No time, and he is somewhat afraid.

SECRET
SECURITY INFORMATION

SECRET
SECURITY INFORMATION

- 3 -

(5)178 - Ex-Unteroffizier; scheduled to be W/T operator on K-118's team; never PRQ'd or traced.

Security Factors: Subject has never met staff personnel; has never been in safehouse; has never seen classified W/T equipment.

W/T Training: None by staff or K-171.

Reason for Dropping: No time.

(6)185 - Ex-Feldwebel; scheduled to be W/T operator for K-136's team. PRQ I, MQQA-86, II MQQA-87; negative traces MQQA-1296 and MQQW-12783; POC in MQQW-13241; POC in WASHF-44573.

Security Factors: Subject has never met staff personnel; has never been in safehouse; has never seen classified W/T equipment.

W/T Training: Spent 11.5 hours training time with KIBITZ-171. Morse Code, Q signals and procedure signs.

Equipment: Tone oscillator, instructograph, keys and headsets.

Reason for Dropping: No time.

4. KIBITZ-197, who has never been PRQ'd or traced, has also been dropped. However, we do have a PRQ on him and will forward it in the near future. As the reason for our dropping him concerns what we might call KIBITZ-15's attitude, we have discussed this case in MGPA-6663. KIBITZ-197 received nine hours of training from KIBITZ-171.

[]

SECRET
SECURITY INFORMATION

SECRET
SECURITY INFORMATION

EQFA- 32

Chief, EE

5 September 1952

Chief, FHB

ATTN: []

OPERATIONAL/CASE

KIBITZ Assets, Problems, and Recommended Future

REF: MSQW-14936

1. Above reference states that the entire Staybehind Project is under the process of review preparatory to authorization of financial allotment for last quarter of (calendar year 1952. Our views on what assets the project has are given herein. As the undersigned has been the case officer on the project just since mid-April, we have taken the ensuing four months to "get our feet on the ground" and attempt to learn where both the weak and strong points in the project were.

2. First, it is believed that the only weak point is that there are just not enough good "stayable" US recruited KIBITZers. Those individual KIBITZers who were far enough along in development--and most important of all, those who had the time, i.e. KIBITZ-10,6,3 were developed, trained, and/or finished as staybehind agents. A short review of the status of the US recruited, or non-KIBITZ-15 side of the program is:

KIBITZ-10 -- completely trained, equipped with two sets and signal plan, and assistant; ready for activation. Is now considered "asleep" but will be recontacted every 3-4 months to keep up motivation.

KIBITZ-6---- completely trained, has signal plan; above ground cache and burial of W/T sets will be made in mid-September; then he will be completed and "asleep" ready for activation.

KIBITZ-3---- Being given part-time W/T training, one week-end a month. Whether he has enough inclination and aptitude for staybehind activity is still a question. However, a decision will be made after late September training period. If he stays in program he probably can be finished as W/T operator around first of

Who does W/T

APPROVED

Distribution
3-COM
3-EE

SECRET
SECURITY INFORMATION

NAZI WAR CRIMES DISCLOSURE ACT

- EXEMPTIONS Section 3(b)
- (2)(A) Privacy
 - (2)(B) Methods/Sources
 - (2)(G) Foreign Relations

Declassified and Approved for Release
by the Central Intelligence Agency
Date: 2005

~~SECRET~~
SECURITY INFORMATION

year when he can come for a 10-day training session.

KIBITZ-7---- Still highly motivated but has been sick and too busy for training. Hope to complete as singleton by late winter.

KIBITZ-9a--- Cold feet seem to be problem here and it's believed that he will have to be dropped. Final decision will be made in next two months. There will be no disposal problem.

KIBITZ-13--- This extrovert type has no desire to be a staybehind agent himself; but as he knows what kind of business we are in and has many connections, we are using him as spotter recruiter with a target of only one or two W/T agents. Target area for his recruiting is Hof-Coburg area.

KIBITZ's 16,11 and 11a are being further developed but progress is slow.

KIBITZers, other US recruited, still being developed.

KIBITZ prospects--there are several new people that we are working on and the emphasis for the fall is being placed on recruiting new types for the US run side of the picture.

3. Actually the last four months have been the best months to get agents into "resident training", i.e. during their regular vacation periods. Getting an agent to leave home, family and local Gasthaus for an extended period of time--and not getting himself and us into security problems is the biggest obstacle we have. So during the summer we concentrated on getting already recruited agents into extended training sessions. Of course the KIBITZ-15 Net had the most agents and K-15 being the aggressive and dynamic character he is he kept the summer training program and all the staff plenty busy. In addition, K-15 has quite a big show, some 150 agents in various stages of development and training; there are many problems. So that I might be on as even ground as possible in my dealings with K-15 and attain [

]s knowledge of the organization that he had seen grow from the embryonic stage, the entire KIBITZ staff, at my direction concentrated on the KIBITZ-15 show all summer. Another reason for such concentration was to find out all we could about K-15 and K-150 and their organization and bring it under as good control as possible.

4. The concentration of effort on the K-15 show has, it is believed, paid off. First, because we have shown progress and accomplished some results. The main result being that K-15 himself and the operation he is running for us have been put under better control mainly that he is not recruiting anyone and everyone he can lay his hands on. The following anecdote will illustrate: [] had been gone no more than three weeks when K-15 told me that as he was an old Brigadekommandant and thus used to training and handling at least a regiment, that he would thus build a regiment of staybehind agents--150 teams of 3-5 men each. I said that was a fine idea but that we had better first see what we had at present. To emphasize, I asked him how many W/T agents or others did we have at the time (early May 1952) who could go on the air in support of western military forces if the radio announced at that very

~~SECRET~~
SECURITY INFORMATION

SECRET
SECURITY INFORMATION

that the Soviets had crossed the zonal borders and were attacking. His astonished reply was "Garnichts". So I then gave him a target of getting 12 operators singletons or in teams finished by 31 December 1952 and said that when this was reached we would discuss further and greater expansion. During the same period (late April and May) I put on the pressure for PRQs and increased security and compartmentation in the KIBITZ-15 Net. These last items are the biggest problem in my dealings with the old boy, but some results have been obtained in this line.

5. K-15 realized the validity of my complaint that expansion was silly until we had showed some results in the actual completion of some trained teams or singletons. Occasionally in the past several months he has strayed a little from this line and attempted to recruit more people or get into grandiose schemes. Each time he has so transgressed I have hopped on him and generally it can be said that he has recruited very few new people but has, with intermittent prodding, turned in complete PRQs on and further developed the already spotted and recruited agents, organized what he has into teams and, best of all, he has done a marvelous job in getting the W/T operators free from their everyday life and into residence training sessions.

6. As the KIBITZ-15 Net is the major portion of the KIBITZ program now, (we hope to remedy this as fast as it is operationally and feasibly possible) we would like to give you some of our views on the operation the colonel is running for us. Some of my comments will be a repetition of previous reports, but to get the proper perspective, they will be made again but in a limited form.

7. Recruitment of KIBITZ-15: K-15 was not actually recruited by a staff officer, but recruited after he had "volunteered" by writing a letter to the US High Commissioner for Germany and offering his services in the fight against Communism. KIBITZ-15's original idea (he volunteered right after the Korean war began) was that he could, with the help of his old Wehrmacht comrades, set up a resistance or guerrilla type organization to fight against the Communists when war broke out here. [] answered K-15's letter by a personal visit and after some several months of visits and Kaffe Klatching turned his ideas toward staybehind activity. The recruitment was made on the basis that K-15 was the expert and that [], who "came from" and reported "directly to Washington", was looking for experts in the staybehind field to set up a network in Germany. Thus, K-15, the expert, was recruited and the US just "furnished money, material, and later W/T instructors". On the K-15 recruitment, one thing must not be overlooked. K-15 is not working for the US, but he is working with the US for the good of Germany. Anyone handling K-15 or meeting him must keep this fact in mind, for if not, relations will get pretty strained. The logical follow-up to this is of course no contract. [], according to K-15, drafted up a contract and discussed it with K-15, but the latter refused to sign or discuss it.

8. KIBITZ-15's status and disposal problems: The next item to consider in the K-15 Net is the future of K-15, i.e., how long can or will he work with us, what commitments have we made to him, what is his status and what disposal problems would he create? "What is my status?" is K-15's favorite question, and one that I hear about once a month on the average and at the next meeting we have after every newspaper blurb about the "planned Wehrmacht". Actually, I have made no commitment to K-15 other than evacuation of his family and himself, and, to the best of my knowledge, [] did not either except possibly by innuendo. An ambiguous promise, if any, was that apparently made by his work

SECRET
SECURITY INFORMATION

SECRET
SECURITY INFORMATION

with the "American Army" that we (the US) would assist him in getting back his colonelcy (his Wehrmacht 201 indicates that he could not have been more than a Lt1 Colonel, but he calls himself "Colonel") and a good position in the European Defense Forces or NATO to go with it. Time and time again K-15 has asked me "what is my status?" At first I gave ambiguous answers but as he became very insistent a time or two I brutally hinted that we had a contract all ready for him to sign. This backed him off, but in a few weeks he was back again with the same old question. This time I asked him "what do you want?" To this there was no answer at all except the statement that "well, I meant that when the contractual agreement and peace treaty are signed how will our organization and relations be affected by it?" or words to that effect. Then he added that he believed he would be offered a commission as colonel in the new Wehrmacht for the following reasons: a) in the 10,000 man officer corps of the Reichswehr his number was in the 2700's, and that now he figured out that it would be between 250 and 300 because of the numbers of his comrades that were wounded, killed, missing too old now (K-15 is just 39) etc; b) he knew some of the people in the Interior Ministry and Blank Office who were planning the new Wehrmacht; c) he had had considerable experience in training combat and "shock", or ranger type, troops; d) he considers himself an expert on Yugoslav and Balkan affairs; and e) he also considers himself an expert on panzer and engineering equipment, and on sabotage due to his long service in the Pioneer-korps. My reply was that the German Army was still only on paper and that it would be another year yet before we had to worry about it. He, K-15, then asked if the US couldn't inform the Bonn Government that he was not to be touched for military service as he was working for the German cause in conjunction with the Americans. I pointed out the fallacy of this idea by point blank saying that I would do better than that and pass his name and generally what he was doing for the western cause to SHAPE. K-15 thought this one a good idea until I followed it up in the next breath and said that of course the SHAPE staff was an international one and that his name and activity would be passed on to all the European nations in SHAPE, or at least their G-2's would hear of it, quickly. This he had never thought of and immediately I was asked not to do anything of the sort; "think of all the French Communists that would know what I was doing". So, for the time being, the "status of K-15" is dormant but it will be a continuous thorn in the side and will no doubt become more of a problem once the German Army does get going, for the Army is K-15's first, last and always love. He is an old soldier that will "never die". It is believed that he can be kept as a principal agent and possibly kept out of the army, if he gets the call, for he is vitally interested in the staybehind program and would just love to get into paramilitary type operations. The latter idea may be the bait that we can use to keep him and/or the answer to his disposal--give him more work, which he really thrives on-- and get him out of just staybehind operation. Of course, that is a problem for the future--one that is not answerable now. One other factor that is to be considered in both the disposal/commitment light is that [] and I have indicated that we will evacuate K-15 and his family in case of hostilities. I believe that this is another factor that is in our favor as far as control of K-15 is concerned, for he is convinced that a war will come and does want to get his family out of Germany in time. He of course has been told that he is being evacuated to help run the staybehind net he has set up--that, too, is a problem that can be considered later, although he would be a help in such operations, he would be a problem, too.

SECRET
SECURITY INFORMATION

SECRET
SECURITY INFORMATION

-5-

9. what has K-15 done and what can he do in building a staybehind operation:

a. Because of his military service he has good access to many of his old army comrades-in-arms and has recruited a number of them. This is good in many ways as they are motivated by a hatred of Russia and a love of the Fatherland (probably little love for the US as such however, but just as the means to the end--defeat of Communism). Secondly, as a native of Schwaben and the Pfalz, he has many connections in those areas, all of which he has exploited operationally. The bad point is that the NIBITZ-15 Net has too heavy a concentration in those areas. I have pointed this out to K-15 and he agrees. In the last month he has attempted to spread north to the Ruhr and along the interzonal border which is our weakest and one of the most important areas. I have prodded K-15 on this point for the last month, and it is hoped that he will come up with some results. On the individual persons recruited by K-15 and his cohorts, we have professional soldiers, all ranks, who are now in many different kinds of employment. Actually they make good agents for this type of work. The only difficulty with this type of person, especially Germans, is that the majority are awed by the "colonel" and his adjutant, K-150, and that if they, 15 and 150, were not around, some, not all, might drop out of the operation. In other words, some of the individuals in the K-15 show have loyalty to K-15 and not to the US case officers working with them. One point that must be brought in here is that with this recruitment of ex-soldiers who were in most cases wartime comrades, the compartmentation of the K-15 Net is not too good. I have tried to find the weak spots in this regard and think that I have uncovered a few of them; but the general fact that many of the individuals in the operation know other members and what each one is doing cannot be denied. With careful scrutiny of each agent or team and the balancing of security against efficiency it is believed that workable and secure teams can be arranged. One way to overcome this is to put, when possible, w/T operators who know each other, operationally speaking, on the same team and have them use the same signal plan. This has been discussed with EUCR and meets their approval. It has also been discussed with K-15 and he, too, agrees that it can be done in certain cases. In some ways this system would increase security by having more transmission sites and operators and eliminating the necessity of moving the very incriminating transmitting equipment around. For example: The Wurzberg area has three w/T operators--198, 199, 200--who know each other well, and what each is doing. There is also a good team leader in K-120 (who is not PR'd yet, but will be soon). Why not put all three (199/200 are man and wife) on same team under K-120 and have them transmit on alternate dates and from alternate places, from same signal plan? This will probably come into effect as our first attempt at setting up a team with one plan and more than one operator. We also intend to put it into effect in other instances when possible.

*Separate
How
Good
Still
Curious*

b. The goal of 12 finished teams by 31 December that I gave K-15 in May has been almost half completed. NIBITZers 156, 177 and 180 have been completely trained and their caches should be finished in next 30 to 60 days. NIBITZers 182, 191, 127, 198 need some more training and in the meantime we are working on their caches. Another three, 161, 192, and 199/200 need a fair amount of training time yet, but should be near completion by the first of the year. With luck regarding shaking some of the w/Ters away for training we may come close to the 12 team goal by January.

*12 teams
by Jan*

SECRET
SECURITY INFORMATION

SECRET

10. Security Features

SECURITY INFORMATION

a. ZIPPER. "e have, and will continue to have, fears that Zipper has or will penetrate KIBITZ-15's show because of the fact that the latter contains so many ex-professional soldiers and both ZIPPERites and KIBITZers belong to veteran groups. We have made a number of checks to determine whether or not the two top people in the K-15 Net--K-15 and K-150-- are connected with ZIPPER, but all have been negative. This does not eliminate the possibility that ZIPPER knows what is going on, however, either through a penetration or an unwitting informant of, as ZIPPER calls it, a "special connection". The unwitting informant possibility is most likely. For example, K-15 who has many connections in military circles and, as will be pointed out below, has absolutely no sense of security. Whether or not ZIPPER's penetration of K-15's operation, if there is any, is dangerous or not to the operation is a question that would probably be a good subject for debate. However, we have been under the impression that KIBITZ was considered to be the US controlled check on ZIPPER's staybehind activities when and if there is a war and the staybehinds are called upon to produce. Although there are no indications of such a penetration, we will continue to watch for and report all indications.

b. Communist Penetration As far as German Communists actually being in the KIBITZ-15 show there is little chance that anyone with even a slightest stigma of past KPD connections would have a chance of getting in the net. In fact, that is the least of our worries for, by and large, K-15 has chosen cohorts who tend more to the NSDAP line than anything else. This does not preclude, however, a real penetration job done by or under Soviet direction. That is an ever-present worry and one that it is sometimes hard to get K-15 to realize for he says to me about once every second meeting that "we have only good Germans in our organization, all of them good 'Russenfresseren'". He will not realize that a good double is usually just such a good German and not a KPD card carrier for 20 years. We shall continue our education program in this light, too.

c. The Bundesamt fuer Verfassungsschutz or other Bonn government agency. This is a good possibility, too, and will become more so as soon as the BfV gets going full steam. No doubt some of our safehouses have been come "interesting" to local German policy and through this channel such information could get to the Federal or a Laender Verfassungsschutzamt. Again, according to K-15, we have nothing to fear from these good Germans who are also western minded and not Communist, even though they are "no-good politicians" (his idea of all politicians). Again we try to explain over again--gradually pushing ourselves into the expert's seat which K-15 has held for some 2 years--that in a staybehind program everyone is your enemy; no one must know what is going on. It is a tough job, but gradually something is sinking in to the old boy's military mind.

d. Physical Security/Tradecraft. Not one classified paragraph of the old Wehrmacht manuals on security of documents or physical security does K-15 remember or want to remember. At least, that was the way he operated in general until I gradually got him to listen to a security lecture about twice a month. Still, when he leaves the safehouse, we have papers on desks, not a real operational paper but, say, lists of telephone numbers, his own real name tax card or letterhead (he uses an alias documented), a sheet of carbon paper outlining a phase of operations, doors left open, etc. All this I found when I "raided" his safehouse-office when he was away on a ten day leave last month. Gradually, I

SECRET
SECURITY INFORMATION

SECRET
SECURITY INFORMATION

am bringing up each point to him. Incidentally, during the same raid I opened his safe (one of the new type issued by our supply) and found no evidence that he carries on a private correspondence "double" operation. It is believed that if he did do so he would have had copies of such correspondence in the safe for German agents are very meticulous in keeping records of what information they pass on to their case officer, no matter who he is. Of course, I could be wrong in my judgment of the man and that this whole attitude of don't-give-a-damn-about-security being just an act to disarm me, but I do not think so. Education of K-15 in security matters has met with some success and I must say that when he is directed to make a correction he does so if it is explained to him and he sees, as he has in all cases, the necessity. He might do the same thing again, though. In tradecraft principles, however, he is quite ignorant and generally does not seem to have the type of mind that assimilates them readily.

11. KIBITZ-15, the Man. This man is a man of action, one who would be much happier if he was told to go out and blow up all the Rhine bridges the day war starts. The job would be done but would be done with about ten times as much explosives as needed, lots of blood would be spilled, K-15 would be there personally lighting every fuse, and keeping them short just for laughs. He is the big he-man type and never lets anyone forget that he was in the late war, wounded nine times and is still walking. On politics he has little interest. Military affairs and winning the war, which he says is inevitable, with Soviets, are his life's blood. To say that he is on the conservative side is putting it mildly for he is still in his heart a damn good Nazi, reading all the right wing/neo-Nazi periodicals (my raid on his safe house office disclosed several) and using the Nazi line on many matters. He is still anti all non-Aryans, bitterly anti-French and anti-British, blaming mainly the French for all Europe's woes.

12. Conclusions:

a. The KIBITZ-15 show is not a perfect one but one that has a lot of assets and one that could become a very good thing. It definitely must be tightly controlled and should be better compartmented. Both of these things can be done.

b. KIBITZ-15 should be led--he cannot be ordered for motivation and psychological reasons--into the track, and kept there, of only recruiting a sub-agent for a given area and running all operations in that area through this sub-agent who will be K-15's cut-out. In this way compartmentation can be increased and K-15 will not be running numbers of agents himself. K-15 has agreed to this in principle and has in the last several months let K-150 run a number of agents himself just in the manner described above.

c. The staybehind singleton and teams in the K-15 net should not be considered top quality-vis-a-vis type of person, security-mindedness, motivation, etc.--as a US recruited and trained agent. But the organization should be kept and expanded slowly.

d. In line with paragraph c above, the signal plan given the KIBITZ-15 W/T operators need not be the best that the US has, but it should be more simple, and thus less of a loss operationally if compromised, than the BROWN/A plans originally scheduled for the operation. This matter has been discussed with Chief, EUCA, and it was decided that the MBER/A plan would be adequate. Better still and more in line with what we could expect for the K-15 Net would be the

SECRET
SECURITY INFORMATION

SECRET
SECURITY INFORMATION

EUCA proposed AMBER/XRAY plan which is simple to operate, comparatively easy to ~~to~~ write up, and not as much of a loss operationally if compromised, or if the agent just ups and quits on us. KIBITZ-15 w/T agents could be switched to AMBER/XRAY when and if it is approved.

12. Recommendations:

yes) a. To get the most out of the KIBITZ-15 operation it is planned that as soon as the personnel and merger situation have cleared up, a senior type case officer should be assigned to exclusively run and control the KIBITZ-15 show and not be connected with any other staybehind agent or operation. In this way, it is believed that the operational maximum had from K-15 and the operation, security and training wise. The assignment of one case officer to run the show would not mean that other case officers or specialists, like [] would be cut off from the operation.

b. The West German staybehind section should concentrate on the recruitment of US controlled single teams or singletons. This would not preclude the recruitment of principal agents to run a net. However, it is strongly recommended that any principal agent recruited in the future be recruited with the specific assignment to spot, recruit and organize an exact number of agents or teams and that such an operation be limited to specific areas that are considered of military or strategic importance in the staybehind program.

Secret but
The
ambitions
for
reception
yes) c. In considering the KIBITZ-15 net it is recommended that it not be cast aside or broken up just yet for it might be considered good camouflage, i.e., let us use it operationally if we can, but, in the meantime keep it going as bait or a dummy target for the Soviets, German government and ZIPPER, with the non-KIBITZ-15 side being the one we are really betting on to come on the air. (part 2)

d. Considerations should be given to using--at a later date-- KIBITZ-15 and/or any part of his net in PM type operations, providing, however, for good case officer control and assignment of a definite target.

SECRET
SECURITY INFORMATION

KIBITZ-15

SECRET
Security Information

Air

EGQW-177

10 Sept 52

Chief of Station, Frankfurt
Attn: []
Chief, EE

Operational/CASE
General Remarks on KIBITZ

1. May we call your attention to MGQW-14936. We are willing to do whatever we can to get the project reapproved, but we need your evaluation of the KIBITZ effort as a basis from which to work.

2. We are glad to note in MGFA-6663 that you have taken a firm hand with KIBITZ 15. We feel that this thing might as well be thrashed out right now. If there is the slightest chance that Ho. 15 is going to kick over the traces at our insistence that he is only a passenger, whereas we are doing the driving, it would be better to have this happen now so that we can begin building up some separate and independent networks not based on his personal whims. There is no need to state that such an attitude on his part following the outbreak of hostilities would be quite a blow.

3. In relation to the above paragraph, it is the opinion here that the K-15 network is as large as we can safely tolerate (perhaps already too large). A quick perusal of the files here shows that you have assigned, or tentatively assigned, numbers up to 137 for sub-agents of K-15. Even assuming that 15 will be loyal to our cause - and this is not too certain - we feel that recruiting should be called to a halt until you have consolidated the present agents into a more coherent and ready-to-operate organization. Of the present personnel of the KIBITZ-15 effort, only one net is actually ready to operate. There are entirely too many loose bodies and unknown quantities in the picture. No more agents should be spotted, recruited, or even considered until the present KIBITZ-15 mob is completely taken care of. The next few months should be spent in completing the training of W/T operators, working out assignments of personnel to individual nets (at least on paper), assignment of nets to specific targets (at least on paper), general briefing of the nets - including the intelligence-collecting members - and a general consolidation and reassessment of the K-15 organization.

4. Once the KIBITZ-15 group has been boiled down into a given number of nets, and these nets have been located vis-a-vis targets, we will be better

SECRET
Security Information

NAZI WAR CRIMES DISCLOSURE ACT

- EXEMPTIONS Section 3(b)
- (2)(A) Privacy
- (2)(B) Methods/Sources
- (2)(G) Foreign Relations

Declassified and Approved for Release
by the Central Intelligence Agency
Date: 2005

SECRET
Security Information

-2-

able to evaluate the advisability of permitting him to continue to recruit further personnel. It is, however, our opinion at this time that he should not be allowed to expand his effort beyond its present size and scope. Once his present personnel have been consolidated, we should then be content to maintain the status quo, while directing our efforts toward the build-up of other nets of considerably smaller size. It is not a good practice to put all our agents in one net.

5. This matter of having too many loose ends waiting to be buttoned up also applies to the American-recruited side of the KIBITZ picture. More time should be spent getting these nets ready to operate. We would like to see all the present KIBITZs buttoned up before any more are recruited; then we would like to see each future net recruited and buttoned up before moving on to the next.

6. Another problem of the present KIBITZ effort, namely the geographic location of the various nets, will be discussed concurrently in another pouch.

7. We realize that the KIBITZ efforts have been seriously handicapped in the past by lack of personnel (case officer personnel), lack of adequate Headquarters support, and lack of specific directives regarding targets, extent of coverage desired, and assignment of equipment. However, some improvement in the amount and type of support we can give you is expected in the not-too-distant future.

8. To recapitulate: Let's get the existing personnel trained, at least tentatively assigned to teams and targets, and briefed; then we can start looking around for more agents.

9. Please let us have your comments on the above, especially paragraphs three and four.

[]

Date of origin: 16 September 1952

SECRET
Security Information

OFFICIAL DISPATCH

VIA: Air DISPATCH NO. EGQW-819
SPECIFY AIR OR SEA POUCH

SECRET
Security Information
CLASSIFICATION

TO : Chief of Station, Frankfurt
Attn: L [] DATE: _____
FROM : Chief, EE
SUBJECT: GENERAL - Operational/CASE
SPECIFIC - POC for KIBITZ 199 and 200
REF: MGFA 6593, 6594, 6780

1. Provisional Operational Clearance has been granted for KIBITZ 199 and KIBITZ 200.
2. We were cognizant of your request for POC by 10 September, but upon receipt of MGFA 6780, we assumed that this deadline did not have to be met since both agents had already received their initial schooling. For this reason we did not cable the POC for these agents sooner. I hope the above was not an unwarranted assumption.
3. Traces on the references for KIBITZ 199 and 200 (MGFA 6780, para. 4) will be forwarded separately.

RW/j1

AN	<u>LC</u>
AB	<u>X</u>
IN	—
PS	—
EX	—
DES	<u>MPB</u>
FI	—

32	6	1	1756
ABSTRACT	X	INDEX	
<u>Rec</u>			
DATE <u>7 Oct 52</u>			

Date of origin: 26 September 1952

RELEASING OFFICER
EE/PT

COORDINATING OFFICER

AUTHENTICATING OFFICER
Peter Sichel

SECRET
Security Information
CLASSIFICATION

FORM NO. 51-28
JUN 1949

GPO 83-22270

NAZI WAR CRIMES DISCLOSURE ACT

- EXEMPTIONS Section 3(b)
- (2)(A) Privacy
 - (2)(B) Methods/Sources
 - (2)(G) Foreign Relations

Declassified and Approved for Release
by the Central Intelligence Agency
Date: 2005

FORM NO. 35-82
NOV 1951

CLASSIFIED MESSAGE

ROUTING

1	
2	
3	
4	
5	
6	
7	
8	

CENTRAL INTELLIGENCE AGENCY

7 OCTOBER 1952

SECRET
SECURITY INFORMATION

OUT 59933

TO: SR. REP. FRANKFURT

[] EE/FI/G 2846

FROM: DIRECTOR, CIA

ROUTINE

EE 6,

2332Z 7 OCT 52

INFORMATION: CF1, OPS, RI 2

DIR 22611

TO: SFRAN

DATE: DIR

RE: EGFA 133, 134

CASE

PIS HOLD ALL KIBITZ RECRUITMENT IN ABEYANCE PENDING RESULT SURVEY ENTIRE
KIBITZ EFFORT EITHER WAY HERE. WILL ADVISE YOU SOONEST POSSIBLE DECISIONS AND
RECOMMENDATIONS THIS SURVEY.

AN	YLC
AB	X
IN	
DE	
EX	
RE	RTD
FI	

7 Oct 1952

ABSTRACT	INDEX
DATE 10 OCT 1952	

CS COPY

EE/FI/

SECRET
SECURITY INFORMATION

EE FI/G
COPY NO.

(44)

IT IS FORBIDDEN TO MAKE A COPY OF THIS MESSAGE

NAZI WAR CRIMES DISCLOSURE ACT

EXEMPTIONS Section 3(b)
(2)(A) Privacy
(2)(B) Methods/Sources
(2)(G) Foreign Relations

Declassified and Approved for Release
by the Central Intelligence Agency
Date: 2005

OFFICIAL DISPATCH

VIA: Air
SPECIFY AIR OR SEA POUCH

DISPATCH NO. EGQW-1095

SECRET
Security Information
CLASSIFICATION

TO : Chief of Station, Frankfurt

DATE: OCT 13 1952

FROM : Attn: FHB/E
Chief, EE

SUBJECT: GENERAL - Operational/CASE

SPECIFIC - KIBITZ 173

Reports Reference to Sec

Subject has been granted full operational clearance.

RW/jl

COPY

Date of origin: 8 October 1952

AN <u>Sec</u>
AB <u>X</u>
IN
FS
BX
DES <u>WFD</u>
FI

32	6	1	9041
ABSTRACT	A	INDEX	
DATE 17 OCT 1952			

RELEASING OFFICER
EE/PI/170

COORDINATING OFFICER

AUTHENTICATING OFFICER
EE/PI/0

SECRET
Security Information
CLASSIFICATION

FORM NO. 51-29
JUN 1949

GPO 63-22240

NAZI WAR CRIMES DISCLOSURE ACT

Declassified and Approved for Release
by the Central Intelligence Agency
Date: 2005

- EXEMPTIONS Section 3(b)
- (2)(A) Privacy
 - (2)(B) Methods/Sources
 - (2)(G) Foreign Relations

OFFICIAL DISPATCH

VIA: Air DISPATCH NO. EGQW-1134
SPECIFY AIR OR SEA POUCH

SECRET
Security Information
CLASSIFICATION

OCT 14 1952

TO : Chief of Station, Frankfurt
Attn: FHB/

FROM : Chief, EE

SUBJECT: GENERAL - Operational/CASE
SPECIFIC - KIBITZ Lia

1. Provisional operational clearance for Subject, issued 6 November 1951, has been cancelled. The office charged with issuing such clearances sent us a memorandum stating that since PRQ Part II information had not been furnished, the POC had expired.
2. Please forward PRQ Part II for Subject so that we may get this thing straightened out. We would also appreciate a report on Subject's present status.

RW/jl

COPY

ANXIC
AB <input checked="" type="checkbox"/>
IN <input type="checkbox"/>
ES <input type="checkbox"/>
EX <input type="checkbox"/>
DES <input type="checkbox"/> HFD <input type="checkbox"/>
FI <input type="checkbox"/>

Date of origin: 9 October 1952

22	6	1	1952
ABSTRACT	<input checked="" type="checkbox"/>	INDEX	<input type="checkbox"/>
DATE 21 Oct. 52. 5			

RELEASING OFFICER
EE/PI

COORDINATING OFFICER

AUTHENTICATING OFFICER
EE/PI/G

SECRET
Security Information
CLASSIFICATION

GPO 83-22240

FORM NO. 51-29
JUN 1949

NAZI WAR CRIMES DISCLOSURE ACT

EXEMPTIONS Section 3(b)

- (2)(A) Privacy
- (2)(B) Methods/Sources
- (2)(G) Foreign Relations

Declassified and Approved for Release
by the Central Intelligence Agency
Date: 2005

VIA: COURIER
(SPECIFY AIR OR SEA POUCH)

DISPATCH NO. EGFA-297

EYES **SECRET** SECURITY INFORMATION CLASSIFICATION ALONE

TO : Chief of Mission, Frankfurt DATE: 15 October 1952
FROM : Chief, FHB ATTN: []
SUBJECT: GENERAL— OPERATIONAL/CALL *shown [] before fwdg*
SPECIFIC— The LC/PROWL Apparatus Flap and its Effect on KIBITZ-15

1. My last meeting with KIBITZ-15 was on the evening of 8 October 1952. At the time of that meeting, neither of us knew of the flap caused by Hessian Minister President Zinn's disclosure of the EDJ's partisan organization. My next meeting with KIBITZ-15 is scheduled for the evening of 16 October 1952 at a safehouse in Heidelberg.

2. Knowing KIBITZ-15 as I do and realizing that the question of his "status" vis-a-vis the German Government has always been of great concern to him, I am sure that he spent the last week doing a great amount of soul searching regarding his activities for us and the future.

3. Among the courses of action KIBITZ-15 might take are the following four:

- (a) Go to the Bonn Government (where he has a number of very good and well-placed friends) or, to ZIPPER and tell all about his activities for us.
- (b) Lay the groundwork, or at least plan it, for doing (a) above, but wait until he has seen me before doing it. In this connection he might even ask my cooperation in making correct connections in Bonn.
- (c) Or he could do the opposite of (b) and plan, with Bonn's help, another "flap".
- (d) Quit entirely or give me a date which will be the latest that he will actively participate in the KIBITZ Program.

4. It is believed that KIBITZ-15 will or has made one of the above choices because the current flap has put him in somewhat of a spot. If the Bonn Government does not know of his operations now, he is still safe from, we will say, unfavorable publicity. However, if the Bonn Government finds out themselves about KIBITZ-15's operations a month or a year from now, they could easily roll him up with a very adverse publicity and thereby nullify his military ambitions which are uppermost in his mind. I have said before

✓ COL-3
EE-3
1- E []
1- E.A. Bl
1- File

117410 COPY TO POB 15 Dec 52
Hand carried by []
SECRET
SECURITY INFORMATION CLASSIFICATION
16-15

FORM NO. 51-28A
MAR. 1949

NAZI WAR CRIMES DISCLOSURE ACT

- EXEMPTIONS Section 3(b)
- (2)(A) Privacy
 - (2)(B) Methods/Sources
 - (2)(G) Foreign Relations

Declassified and Approved for Release
by the Central Intelligence Agency
Date: 2005

SECRET

ECFA-297

SECURITY INFORMATION

E Y E S - 2 - A L O N E

in dispatches that he has no regard for Bonn or for politicians; this is true! However, he is not dumb and, with his military ambitions, he certainly realizes that it would be much better for him to be working for the Bonn Government in a quasi or official capacity, than to be working for the Americans in clandestine activity.

5. With the above possibility in mind, the undersigned and [] discussed all angles of the KIBITZ-15 Net in respect to the current flap, with [] and []. We have drawn up the following balance sheet regarding the KIBITZ-15 Net:

WHY WE SHOULD KEEP THE KIBITZ-15 NET.

1. It is a going group which could possibly (?) be expanded under tight control.
2. We have nothing to replace it.
3. It could be used as camouflage for our staybehind operations.
4. It could be turned into a paramilitary (Resistance) organization(?).
5. It is anti-Soviet in its motivation.
6. It could be used in a machiavelian sense as bait for the Soviets in time of hostilities.

WHY WE SHOULD NOT KEEP THE KIBITZ-15 NET.

1. Getting rid of it now, if possible, i.e. turning it over to the Federal Government or to ZIPPER, would eliminate possible discovery of such organization at a later date and an ensuing flap.
2. In relation to (1) above, turning it over to Bonn now might be used as a "sop" in our relations with Bonn over the present flap.
3. If KIBITZ-15 has not already done so, he could at any time "turn us in" to Bonn.
4. In relation to (3) above, control of KIBITZ-15 will always be a problem.
5. The compartmentation of the Net as a whole is not very good and the possibility of compromise or its discovery by the German Government is ever present.
6. Administratively — from our viewpoint — now would be the time to turn it over to Bonn for: we have three new safehouses which are unknown to KIBITZ-15; [] is going home on leave in November; [] is being considered for reassignment to a position of more responsibility, by EUCA.
7. KIBITZ-15 has always been worried about his "status" and he is sure to bring the point up now. "Turn the entire operation over to Bonn", might be our ready answer as far as our relations

SECRET

SECURITY INFORMATION

SECRET
SECURITY INFORMATION

ECFA-297

E Y E S - 3 - A L O N E

WHY WE SHOULD NOT KEEP THE KIBITZ-15 NET.

with him are concerned in seeking a painless solution.

8. Because of bad compartmentation, doubts over control and motivation of KIBITZ-15, (what does he really want) the question "can it ever operate" is always in my mind.

9. The type of people in the KIBITZ-15 Net, although strongly anti-Soviet, do not always possess the high mental and initiative standards required of a staybehind agent.

10. The loyalty of the whole show is more towards KIBITZ-15 and/or Germany than towards the U.S. or the West.

11. During the period which the undersigned has been case officer, the KIBITZ-15 show has taken up 75 per cent of the time of personnel assigned to the project and about the same percentage of money allotted. Question: Aren't we putting most of our eggs in one basket?

12. KIBITZ-15 has stated that he has good connections in Bonn, especially in the Blank Ministerium which is planning the new German Army. Whether or not such "connections" know of KIBITZ-15's activities for us is unknown. However, they could be used, flap-wise, by either party at any time.

13. Although KIBITZ-15 has never mentioned specifically ZIPPER, he no doubt has either witting or unwitting connections with ZIPPERITES. These also could be used by either party to compromise the operation.

6. In considering the above, which might be called the pluses and minuses of what should be done with KIBITZ-15, the facts known to KIBITZ-15 and his sub-agents that might compromise us are:

(1) He knows our general operating procedure.

(2) He knows safehouse in Unterschondorf, (now being released, but it will still be used operationally by EOB) Ulm and Heidelberg. However, arrangements have been made to exchange the Ulm place for a new house -- unknown to the KIBITZ-15 Net -- effective this week.

(3) KIBITZ-15 and some of his sub-agents know the operational cars used by case officers. It is not known whether or not KIBITZ-15 (or others) has had the foresight to take down the license numbers.

(4) KIBITZ-15 himself very probably suspects that our headquarters is in Frankfurt even though we have never given him any indication that it was or was not. He has this knowledge from the fact that [] had

SECRET
SECURITY INFORMATION

SECRET
SECURITY INFORMATION

EGFA-297

E Y E S - 4 - A L O N E

KIBITZ-15 to dinner at his home in the HICOG Project a week before departing for the United States. During the dinner, KIBITZ-15 learned []'s correct name when []'s child said, "Daddy, what name do we use tonight, Kessler or (true name)".

(5) KIBITZ-15 and a number of his sub-agents know:

[] at []
[] [] [] [] it is possible that KIBITZ-15 knows []'s true name through the license number of []'s privately owned vehicle which KIBITZ-15 has seen. [] sold this vehicle about a month ago and if KIBITZ-15 did not get his name previously, he has no way of getting it now.

[] as [] []
[] as [] []
[] as [] []
[]'s [] []
[] as [] []
[] as [] []
[] also met KIBITZ-15 one time.

(6) Although the cover used by case officers in KIBITZ-15 show has always been "U.S. Army out of Washington", KIBITZ-15 has given me some indications that he at least suspects that we are DYCLAIM for he has mentioned, on two occasions, [] and asked obliquely what connection we had with him. [] []

(7) KIBITZ-15 knows or can easily find out, all data on household help in Ulm and Unterschondorf.

(8) KIBITZ-15 probably suspects that we have operations other than his in the staybehind field. (Both the U.S. staff side and KIBITZ-15 Net agents were trained and met in the Ulm and Unterschondorf safehouses prior to the undersigned's taking over the operation. This was changed in late July when we obtained the Ludwigsburg safehouse which is used only for the non-KIBITZ-15 side of the program.)

(9) KIBITZ-15 has seen all of our secret W/T equipment — RS-1, RS-6 and TR-1 W/T sets, together with ADK, oscillator and instructograph for W/T. Operators in KIBITZ-15 Net and, of course, all sub-agents who are W/T candidates have seen and used this equipment if they were cleared.

SECRET
SECURITY INFORMATION

SECRET
SECURITY INFORMATION
 E Y E S - 5 - A L O N E

(10) KIBITZ-15 and his operators who have been cleared and/or reached a pertinent stage in training, are familiar with our W/T operating procedure and BROWN/A signal plan. No W/T operator or any other person in the KIBITZ-15 Net, including KIBITZ-15, has in his possession a signal plan of any type, crystals, or a W/T set other than a TR-1. (KIBITZ-15 has four TR-1s in gas cans given to him by [] These will be picked up.)

7. In considering all of the above points and the fact that we have no contract with KIBITZ-15 -- he refused to sign one for [] and mentioned this refusal to me soon after I took over the operation -- and the fact that he always emphasizes that he is working with the U.S. for Germany, it is believed that the entire operation should be turned over (by DYCLAEM approach) to the Bonn Government or to ZIPPER as soon as possible. If this is not feasible immediately, it is believed there should be a moratorium on operations until the position of DYCLAEM is clarified in regard to the establishment of clandestine para-military/staybehind operations in Germany.

[This proposed action pertains only to the KIBITZ-15 Net in the staybehind program. The U.S. recruited and controlled staybehind agents are not believed a danger, security-wise, to DYCLAEM. This is based mainly on the fact that the compromise of ~~any~~ any one of U.S. staff controlled staybehind agents would be the compromise of only one man or team and not the entire program. The undersigned has, over the last sixty days, placed operational emphasis on the U.S. staff side of KIBITZ and, if KIBITZ-15 and his Net are turned over to the German Government or ZIPPER, this will free staff personnel to concentrate on individual U.S. recruited and controlled agents. Considering the reassessment of the U.S. position in this field, it is believed that it would pay us to concentrate on recruiting and training a small or reasonable number of high-quality U.S. controlled staybehind agents instead of the mass-type organization that KIBITZ-15 or his like will always evolve us in. (All recruiting has, however, been stopped temporarily per DIR 22611, 8 October 1952.)]

8. At my next meeting with KIBITZ-15 on the evening of 16 October 1952, I will, of course, have to see what his reaction to the flap has been before taking any action. Here is my proposed plan of action:

(a) If KIBITZ-15 says he wants to go to Bonn with his case, I will agree (as suggested by [] and []) and attempt to have him let me make the arrangements for him to see someone in Bonn, or in the "Gehlen Gruppe". If he says that he will go himself, I will attempt to get the "Who and When" so we can act first.

(b) If KIBITZ-15 does not directly say what he has done, I will attempt to elicit all I can about what he has done so we can act accordingly.

SECRET
SECURITY INFORMATION

SECRET

SECURITY INFORMATION

ECFA-297

9. N.B. - In a meeting between the undersigned, [] and [] on 3 November 1952, the following course of action in connection with the KIBITZ-15 program was agreed:

a. At an exploratory meeting which I would have with KIBITZ-15 in the near future, I would advise him that because of developing German sovereignty, German participation in EDC and the relationship of both to NATO, we were giving some consideration to advising the Federal Government of the existence of the net, but before so doing, (1) wanted to obtain his reaction, (2) his opinion as to who specifically should be contacted in the government if an approach were made, and (3) determine whether he had as yet made any approach himself and if so, to whom.

b. If KIBITZ-15 were agreeable to such an approach and no other adverse factors appeared, we would then contact the government (probably the BfV or the Interior Ministry), advise them in general terms of the net and the purposes for which it had been organized, point out that to date there have been no security "flaps" resulting from the net's existence, stipulate our intention to maintain the net under direct U.S. control or ZIPPER until such time as the Federal Government was prepared to take it over, and ask for Federal Government reaction to these proposals, and specifically for their recommendation as to whether the net should be passed to ZIPPER, held by us, or phased out.

10. Before implementing the proposals contained in paragraph 9, it is our understanding that the personal approval of [] would be required since a disclosure of our operations -- although on general terms -- to the Federal Government, is involved. The approach to KIBITZ-15 outlined in paragraph 9a, also must await further information from POB on the details of KIBITZ-15's possible connection to ZIPPER, directly or through the Selbsthilfe.

11. As an alternative to the action proposed in paragraph 9, we might discuss with [] and his STORCH case officer, the advisability of turning over the net to ZIPPER with or without any recourse to the Federal Government. The factor favoring this alternative is the STORCH program itself within ZIPPER. We understand that ZIPPER is giving consideration to expanding STORCH, and has held discussions in this vein with USAREUR.

12. Formal approval of the course of action suggested in para 9 or 11. above, or an alternative directive is requested.

NOTED BY: []

APPROVED: []

HGS/cfp

SECRET

SECURITY INFORMATION

In view proposed review by a qualified officer this will be history by the time you receive it. HGS

COURIER

EGFA- 289

**SECRET
SECURITY INFORMATION**

Chief of Base, Pullach

22 October 1952

Chief, FHB

ATTN: []

OPERATIONAL

"Special" Name Trace in ZIPPER Files on Walter KOPP

1. This is to confirm conversation between [] and [] on 20 October 1952, regarding subject and his possible connections to the "Selbsthilfe", a veterans group in Stuttgart.

2. Personal details on subject are:

Name: Walter KOPP

Date of Birth: 21 March 1913

Place of Birth: Alsenz, Pfalz

Present Address: Buttenweissen bei Augsburg

It is requested that POB/US files be checked on subject.

3. Per our conversation, it is also requested that ZIPPER files be checked ONLY if it can be done securely; i.e., a POB/US staff member making the file check himself as you outlined in our conversation. It is realized that this is difficult for you to do, but in this case it would be greatly appreciated if you would make the effort in the near future. As we discussed on 20 October 1952, a usual "disguised" check of ZIPPER files would bring subject's name to the attention of not only ZIPPER, but the BfV at both Land and Bund level.

4. It is requested that any further information POB has or can obtain unobtrusively from ZIPPER on the "Soldatenselbsthilfe" in Sueddeutschland, run by former Colonel Albert Paul Schnez, be furnished the undersigned. We have copies available of MGLA-8343, MGLA-8540 and MGLA-11398.

[]

APPROVED: []

RI COPY

HGS/cfp

DIST: POB-2 VEE-3 COM-3

**SECRET
SECURITY INFORMATION**

NAZI WAR CRIMES DISCLOSURE ACT

- EXEMPTIONS Section 3(b)
- (2)(A) Privacy
- (2)(B) Methods/Sources
- (2)(G) Foreign Relations

Declassified and Approved for Release
by the Central Intelligence Agency
Date: 2005

OFFICIAL DISPATCH

VIA: Air
SPECIFY AIR OR SEA POUCH

DISPATCH NO. EGQW-1307

SECRET
Security Information
CLASSIFICATION

OCT 22 1952

TO : Chief of Station, Frankfurt
Attn: FHB/ []
FROM : Chief, EE
SUBJECT: GENERAL - Operational/CASE
SPECIFIC - KIBITZ 218

DATE: _____

Regals referments

Provisional operational clearance has been granted for Subject.

COPIES

Date of origin: 16 October 1952

Rw/jl

AN PKP
AB X
IN
PS
BX
DES NPD
FI

3016 9055
LIST OCT INDEX
DATE 24 OCT 1952
Phine

RELEASING OFFICER
EE/FI/Po

CS COPY
COORDINATING OFFICER

AUTHENTICATING OFFICER
EE/FI/G

SECRET
Security Information
CLASSIFICATION

FORM NO. 51-28
Dec 1949

GPO 83-22240

NAZI WAR CRIMES DISCLOSURE ACT

- EXEMPTIONS Section 3(b)
- (2)(A) Privacy
 - (2)(B) Methods/Sources
 - (2)(G) Foreign Relations

Declassified and Approved for Release
by the Central Intelligence Agency
Date: 2005

VIA: AER
(SPECIFY AIR OR SEA POUCH)

DISPATCH NO. EGFA-304

SECRET
SECURITY INFORMATION
CLASSIFICATION

TO : Chief, EE

DATE: 24 October 1952

FROM : *[Signature]* Chief, FHB

ATTN: L J

SUBJECT: GENERAL OPERATIONAL/CASE

SPECIFIC: Possible Link Between KIBITZ-256 and KIBITZ-261

REF: EGFA-276 and EGFA-273
fw *fw*

1. In references given by subjects -- question 30, PRQ Part I referenced above -- there is an indication of what might possibly be a lateral tie between these two agents in the KIBITZ-15 Net. Frau STEUERWALD is given as reference for both; however, KIBITZ-256 lists her Frau STEUERWALD as living in Albisheim -- while KIBITZ-261 lists her Frau STEUERWALD as living in Gauersheim. The towns are quite close to each other and there is a possibility that both STEUERWALDS are in the same family.

2. This is another indication (see EGFA-275) of close ties between the various people working under KIBITZ-15.

3. An attempt will be made to determine the connection, if any, between the STEUERWALDS mentioned above and KIBITZERS 256 and 261.

APPROVED: *[Signature]*

HGS/cfp

[Handwritten initials]

AN	<i>LKC</i>
AB	<i>X</i>
IN	
PS	
BX	
DES	<i>WFD</i>
FI	

DIST:

✓ EE-3
COM-3

CS COPY

FORM NO. 51-28 A
MAR. 1949

SECRET
SECURITY INFORMATION
CLASSIFICATION

9134

NAZI WAR CRIMES DISCLOSURE ACT

- EXEMPTIONS Section 3(b)
- (2)(A) Privacy
 - (2)(B) Methods/Sources
 - (2)(G) Foreign Relations

Declassified and Approved for Release
by the Central Intelligence Agency
Date: 2005

VIA: AIR
(SPECIFY AIR OR SEA POUCH)

DISPATCH NO. EGFA-312

SECRET
SECURITY INFORMATION
CLASSIFICATION

TO : Chief, EE

DATE: 24 October 1952

FROM: Chief, FHB

ATTN: []

SUBJECT: GENERAL— OPERATIONAL/CASE

SPECIFIC— Disposal of KIBITZ-171

REF: EGFA-313

1. KIBITZ-171 was a W/T instructor in the KIBITZ-15 Net from October 1951 until June 1952. He was originally recruited by KIBITZ-15 and []

2. Prior to his employment as a fulltime W/T instructor for KIBITZ, subject was employed by Rhine Military Post, Kaiserslautern in the Signal Section. At the time of his employment, arrangements were made with Rhine Post to have him rehired by them when he would no longer be of operational use to us. Such arrangements were laid-on through ID EUCOM. In June of this year, we decided that subject was unsuitable for intelligence operations and should be dropped.

3. June, July and August of this year were spent trying to have KIBITZ-171 rehired by Rhine Military Post. [] carried on all discussions with the Chief of Personnel, Rhine Post. Due to the cut-down of indigenous personnel employed by military installations in Germany and the fact that KIBITZ-171's inadequacies were also known by the Signal Section at Rhine Post, we were told — despite their promise to rehire him — that Rhine Post could not re-employ KIBITZ-171.

4. The undersigned then took the KIBITZ-171 case to the HARVARD Unit and spoke with []. In September, HARVARD was asked (EGFA-95, to COM only) to try to get KIBITZ-171 a job in Germany and at the same time lay on necessary arrangements for possible emigration. It was felt that emigration was the best solution to our security problem. [], during September, saw a chance to have KIBITZ-171 emigrate to Australia. (Their attempts to get him a job on the German economy were not started due to the chance of his possible emigration in the very near future.)

5. On 8 October, 1952, [], under the alias of Mr. Hendricks, met KIBITZ-171 for the first time. An excellent "sales job" on why KIBITZ-171 should emigrate to Australia, had been done at undersigned's direction previously by KIBITZ-15. KIBITZ-171 was agreeable to emigrating to Australia, only questioning the job and personal security situation there saying that he did not want to become just an ordinary laborer, but wanted to stay in his profession — the Radio/Electronic field. Arrangements were made by [] to have KIBITZ-171 meet the Australian Consulate General in Frankfurt on 13 October 1952. This KIBITZ-171 did and we are now awaiting the results

✓ EE-3 HARVARD-1
COM-3

FORM NO. 51-28A
MAR. 1949

ATTACH: 1 for EE

SECRET COPY
SECURITY INFORMATION
CLASSIFICATION

6-1-1140

NAZI WAR CRIMES DISCLOSURE ACT

- EXEMPTIONS Section 3(b)
- (2)(A) Privacy
 - (2)(B) Methods/Sources
 - (2)(G) Foreign Relations

Declassified and Approved for Release
by the Central Intelligence Agency
Date: 2005

SECRET
SECURITY INFORMATION

- 2 -

of his emigration application. If the Australians do not take KIBITZ-171, the HARVARD Unit will attempt to emigrate him to Canada or possibly to the United States. If KIBITZ-171 emigrates to Australia, his passage will be paid by the Australian Government in connection with PICME. Passage to other countries will be taken care of by HARVARD or countries involved. In addition, [] has intimated to KIBITZ-171 that he will be given a small "bonus" upon emigration to aid him to start his new life.

6. Reasons for disposal of KIBITZ-171 are:

a. Subject is immature and has a personality not suited to clandestine activities. His main faults are his lack of regard for money and his attraction to members of the opposite sex.

b. Original control of subject and his operational activities are not considered to have been secure in that subject learned too many true identities of his students (other W/T operators in the KIBITZ-15 Net).

c. Operationally, the KIBITZ-15 Net is being slowed down and we have no further need of subject's services.

d. Because of the sensitive nature of the Staybehind Program and (a), (b) and (c) above, subject's evacuation from Germany would have to be accomplished at the outbreak of hostilities. For better security now and elimination of evacuation problems, it is recommended that he be emigrated at once.

7. KIBITZ-171 knows the following:

a. W/T Operational Data: DYCLAIM W/T procedure and training methods. (He has instructed some 14 W/T agents in the KIBITZ-15 Net.) He is familiar with TR-1, RS-6, RS-1, Bud Oscillator, AdK, MP-1 SX-71, Halli-crafter, crypto system and signal plan system. NOTE: All equipment that was used by KIBITZ-171 in his duties as instructor, has been taken away from him.

b. Subject knows the following staff W/T instructors: []
[] as Mr. Robert C. Larrie; [] [] -- alias unknown.

c. Subject also knows the following staff personnel: []
[] as Nicholas Kessler; [] [] as Dennis H. Donn; []
[] as Edward Hartman; and [] [] as George.

d. Subject knows the following safe houses -- all of which are going to be vacated by KIBITZ within the next month: Heidelberg -- Rohrbacher Strasse 56; Ulm -- Galgenbergweg 20; Unterschondorf -- Bahnhof Str. 10.

e. Subject knows operational vehicles of: [] and []
[] , as well as [] []'s. Also the one used by []
[] which [] [] now has.

SECRET
SECURITY INFORMATION

SECRET
SECURITY INFORMATION

- 3 -

f. Subject knows [redacted] as Mr. Hendricks who will be the only staff personnel seeing subject from now on.

g. Subject knows KIBITZ-15 by true name and all personal data, and exactly what KIBITZ-15 is doing for us.

h. The wife of KIBITZ-136 is KIBITZ-171's sister. KIBITZ-136 is one of KIBITZ-15's favorite "team leaders" and confidant. KIBITZ-171 knows that KIBITZ-136 is in the KIBITZ-15 Net and vice-versa.

i. KIBITZ-171 also knows the following agents in the KIBITZ-15 Net: (Other than KIBITZ-15 and KIBITZ-150, it is believed that most of the agents listed below know KIBITZ-171 as Hans Schaeffer)

- KIBITZ-150 -- by true name and all personal data
- KIBITZ-127 -- by true name but not address
- KIBITZ-156 -- by true name but not address
- KIBITZ-161 -- by first name only
- KIBITZ-173 -- by true name, but not address
- KIBITZ-177 -- by true name and address
- KIBITZ-180 -- by first name
- KIBITZ-182 -- by sight
- KIBITZ-190 -- by sight
- KIBITZ-192 -- by full name and all personal data
- KIBITZ-197 -- by sight
- KIBITZ-198 -- by true name and all personal data
- KIBITZ-199/200 -- by true name and all personal data
- KIBITZ-145 & 185 -- by true name; however, these agents have been dropped

KIBITZ-171 has not seen anyone in KIBITZ-15 Net, other than KIBITZ-15, since June, when he gave basic W/T instruction to KIBITZ-199/200. This 4-month period has probably dulled his memory somewhat of names etc. In addition, KIBITZ-15, whom KIBITZ-171 respects quite a bit, has given him a severe security lecture and collected all notes, etc., he could from KIBITZ-171.

8. In EGFA-197, we requested a name check from CLS on subject and also necessary action by CIC that they would withhold knowledge of subject's intelligence activities from the Australians or other country requesting a check in regard to KIBITZ-171's emigration applications. [redacted], Chief CLS, informed undersigned verbally that CIC had no record (other than his KIBITZ activities) of subject and that they would so state when any inquiries regarding his emigration were made.

9. Subject had false documents furnished him by MKTOPAZ in the name of Hans Schaeffer. These were a Kennkarte and driver's license. These have been taken up and are now held in his file here. Subject realizes that his employment as W/T instructor was a temporary position. It is not felt that

SECRET
SECURITY INFORMATION

SECRET
SECURITY INFORMATION

there will be any problem with subject, security-wise, if we keep our portion of the agreement with him; that is, getting him another job or, according to recent developments, help him to emigrate and get a new start in life. KIBITZ-171 did not sign a contract for his employment as W/T instructor in KIBITZ-15 Net. Files here indicate (MGKA-33041, 25 September 1951) that subject was hired by verbal agreement for 400 DM per month with periodic increases up to 600 DM per month by [redacted]. He, however, received only one increase and has been paid only 450 DM per month plus 26.00 DM for Krankenkasse payments since January 1952. We will request [redacted] of HARVARD to obtain a quit claim from subject once he is on his way to the boat and/or resettled on German Economy. HARVARD will continue to pay him until he is emigrated or resettled.

10. A copy of HARVARD's PRQ Parts [redacted] II (detailing personal data on disposal cases) is attached for EE files. A copy of HARVARD's PRQ Part I is forwarded by EGFA-313.

[redacted]

C.F.

HGS/cfp

APPROVED: [redacted]

*cc detached
and filed in C/10A
file 50-365*

SECRET
SECURITY INFORMATION

[redacted]

VIA: ATR
(SPECIFY AIR OR SEA POUCH)

DISPATCH NO. EGFA- 328

SECRET
SECURITY INFORMATION
CLASSIFICATION

TO : Chief, EE
FROM: JK Chief, FHB

DATE: 27 October 1952

ATTN:

SUBJECT: GENERAL—OPERATIONAL/CASE

SPECIFIC—⁰Dropping of KIBITZ-9a

REF: MGKA-22261, MGKW-11941

1. References are PRQ Part I and granting of full operational clearance respectively for subject.

2. Subject is hereby dropped without prejudice. Subject has shown no interest for some eight or nine months in continuing training as a W/T operator in the KIBITZ Program. The main reason for this lack of interest appears to be that subject has gotten "cold feet".

has made three attempts in sixty days to contact subject in an effort to set a new training date. In each attempt, call or letter was either ignored or subject very hastily said he did not have time or did not know when he could even talk to

3. Subject was trained on a part-time basis on two occasions in 1950 and a number of occasions in 1951 -- the last being on 12 July 1951. His previous radio experience gave him a good basic knowledge of radios and, with part-time training one or two hours two or three days during May, June and July 1951, he reached 15 wpm receiving and 11 wpm sending.

4. Operationally subject knows the following:

a. Subject never received any training in DYCLAIM W/T procedure.

b. Subject has seen but does not have in his possession the following W/T equipment: instructograph; ADK; oscillator and SSTR-1.

c. Subject was trained by the following staff W/T instructors: and (none are with KIBITZ Program now) under unknown aliases.

d. Subject knows the following staff personnel:

as Mr.
 as Mr.
 Mr.
 as Mr.

DIST:
 EE-3
COM-3
A&L-1
FIN-1

FORM NO. 51-28A
MAR. 1949

SECRET
SECURITY INFORMATION
CLASSIFICATION

NAZI WAR CRIMES DISCLOSURE ACT

Declassified and Approved for Release
by the Central Intelligence Agency
Date: 2005

EXEMPTIONS Section 3(b)
(2)(A) Privacy
(2)(B) Methods/Sources
(2)(G) Foreign Relations

SECRET
SECURITY INFORMATION

- 2 -

e. Subject knows only the Ulm Safehouse, Galgenbergweg 20 (which we will vacate by 1 November 1952).

5. [] requested in HGKA-30937, 18 July 1951, 500 DM to assist KIBITZ-9a in the purchase of a motorcycle. This was approved by COM here. EE approval was given in HGKW-11763, 4 December 1951. [] gave the money to KIBITZ-9a who then purchased a motorcycle. [] of Supply Section, COM, checked supply records and there is no supply accounting of this motorcycle or the 500 DM given to KIBITZ-9a for this purchase.

6. There is no secure means available to the undersigned to obtain the motorcycle or reimbursement for the money given to KIBITZ-9a for this purchase. As stated above, KIBITZ-9a has "cold feet" and any attempt on our part to discuss reimbursement now would probably be a security risk. It is therefore requested that accountability for this expenditure be dropped from the KIBITZ account in Finance, and that supply be so notified.

7. Dropping of subject will not pose any security problems because, with the move of KIBITZ operations out of Ulm, he will have no link or tie-in to staff personnel or the operation. In addition, his operational inactivity for over a year make remote the possibility that his KIBITZ relationships would lead to surveillance of the operation. There is no indication that his "cold feet" have lead to his doubling on us. In fact, from what I can learn of the man, it is felt that he would like to forget the whole episode and would not, in self protection, mention it to anyone. His year's lay-off from operations has probably served to blurr his memory of the KIBITZ project.

APPROVED: _____

[]
HGS/cfp

SECRET
SECURITY INFORMATION

[]

VIA: AIR COURIER
(SPECIFY AIR OR SEA POUCH)

DISPATCH NO. EGFA-314

SECRET
SECURITY INFORMATION
CLASSIFICATION

TO : Chief of Mission, Frankfurt

DATE: 28 October 1952

FROM : Chief, FBI

ATTN:

SUBJECT: GENERAL— OPERATIONAL/CALL

SPECIFIC— Report on 16 October 1952 Meeting with KIBITZ-15 and
Reaction to BDJ "FLAP"

REF: EGFA-32, EGFA-289, EGFA-297 (*being sat later*)

DATE:	30. OCT. 1952
1-	GD
2-	
3-	
4-	
INFO:	<input type="checkbox"/> 7
BOARD	CHRONO

1. The undersigned arrived at the Heidelberg KIBITZ safehouse at 1930 hours, 16 October 1952, for a scheduled meeting with KIBITZ-15. I had not seen KIBITZ-15 since the "BDJ Apparatus Flap" made the papers and this meeting would disclose his reaction.

2. Before entering the safehouse, I made a check of the surrounding area to see if the place was under surveillance. To the best of my knowledge it was not. KIBITZ-15 greeted me with an air of self-confidence which he had never before exhibited during the six months which I have been running him. arrived at 2030 hours and remained until the end of the meeting. He also noticed no indications of surveillance.)

3. The next apparent difference in the "old boy" was his great regard for security, for he immediately shut the windows (the wooden shutters had already been tightly drawn on windows) before we began to talk. This increased security awareness permeated the entire meeting, a great improvement I must say, but I wonder why the sudden development.

4. KIBITZ-15 immediately brought up the "BDJ Flap" and said it certainly was getting a lot of publicity and that in certain ways it would affect our operations, but that we could discuss it later as there were a number of day-to-day problems to discuss first. He then handed me a two-page agenda for the meeting. (I have KIBITZ-15 give me an agenda of main points to be discussed at each meeting so that I have a record of his activities and ideas. I make my own notes for points I want to discuss — a copy of which KIBITZ-15 does not get. I might add, that KIBITZ-15 has no written material or instructions from me or from other staff personnel.)

5. Among a number of routine operational points brought up was a proposal that we furnish, in addition to normal expenses, some 14,000 DM to the operation. This — financially the "biggest idea" that KIBITZ-15 has ever had — would be broken down as follows:

a. 8,000 DM to KIBITZ-177: This W/T Operator, who is nearly

DIST:
COM-1 ✓
EE-3

FORM NO. 51-28 A
MAR. 1949

SECRET
SECURITY INFORMATION
CLASSIFICATION

NAZI WAR CRIMES DISCLOSURE ACT

- EXEMPTIONS Section 3(b)
- (2)(A) Privacy
 - (2)(B) Methods/Sources
 - (2)(G) Foreign Relations

Declassified and Approved for Release
by the Central Intelligence Agency
Date: 2005

SECRET
SECURITY INFORMATION

- 2 -

finished training, is married, has four children and was formerly a proprietor (Paechter) of a gasthaus in the East Zone, fleeing to the West in 1949. He is now a waiter in a town outside Stuttgart and has only one and a half rooms for his large family. KIBITZ-15 has called these quarters worse than a pig sty. Such conditions, and we agree with KIBITZ-15 on this, do not make it conducive for a clandestine W/T operator to produce. The 8,000 DM requested would be to pay for the purchase of the lease and inventory of a gasthaus near Hof, which KIBITZ-177 could derive his income from, house his family in and use as an operating base for staybehind activities -- the KIBITZ-15 Net has no agents in North Bavaria. (KIBITZ-15 had told me about this "idea" before, but no price was mentioned.)

b. 3,000 DM for KIBITZ-137: This is the amount this team leader, and confidant of KIBITZ-15's, needs to purchase a Schloss near Kaiserslautern which contains 12 apartments of very low standard. KIBITZ-137 can buy and fix the place up for 15,000 DM, but he only has possibilities of getting together 12,000 DM. If we gave him the difference he will purchase the place, and it can be used as an operating base for the KIBITZ-15 Net, KIBITZ-137 and W/T operator, KIBITZ-161.

c. 2,000 to 3,000 DM for KIBITZ-162 (A woman): This would be used for renting and furnishing her an apartment in Wiesbaden (KIBITZ-15 has no W/T agent there) and sending her to business school where she can learn to be a secretary. Then she could get herself a job in Wiesbaden, using her apartment as a W/T operating base.

6. I told KIBITZ-15 that these proposals all had merit, but that I could not say whether or not the money would be made available. We then discussed a number of other operational points before going into the BDJ problem.

7. Throughout the entire discussion of the above points, KIBITZ-15 acted oversure of himself in all matters, nevertheless remaining pleasant to [] and myself. I might say that he acted as though he was not an agent at a clandestine meeting in a U.S. safehouse, but again in the Wehrmacht uniform of full Colonel discussing military plans with his staff.

8. KIBITZ-15 then turned the conversation to the "BDJ Flap", saying that the organization itself could not have been run strictly on German initiative; that all in all, he did not object to the idea of having such an apparat or to the people in it. When questioned directly as to what he thought of the leaders of the BDJ Apparatus, he said they were good men -- just the adventurous types gone a little wild. He did not approve of Pask's "hiding behind the Americans" once the organization was made public, however. In regard to the "black list", KIBITZ-15 more or less dismissed it saying that it was all SPD propaganda and that the SPD had certainly taken full advantage of the "flap"

SECRET
SECURITY INFORMATION

SECRET
SECURITY INFORMATION

- 3 -

and the "black list" in their relations with the Bonn Government and the Americans.

9. When asked about how he thought the "flap" would affect our (i.e. KIBITZ-15) operations, he said that it certainly indicated that increased security measures would have to be taken by us and everybody in our organization. This led us to a discussion of the LfVs, BfV and German police vis-a-vis "our" operations. When asked the direct question of how Bonn would feel if they learned of our staybehind program, KIBITZ-15 answered, "They will tolerate it".

10. He then pushed [] and me on our knowledge of the EDJ. We both denied any knowledge prior to the press reports and assured him we had nothing at all to do with the organization. He did not appear to believe this completely, but made no effort to draw us out further. KIBITZ-15 then practically boasted that he knew the "EDJ Flap" was coming two weeks before Minister President Zinn made his announcement before the Hessian Landtag. I acted quite surprised at this two weeks' "scoop" and asked him his sources. At first he was very indifferent to the question saying he "had many connections". But I repeated the question and he admitted his sources were "friends in the Selbsthilfe in Stuttgart". I asked him what kind of organization this was. KIBITZ-15 told me it was an organization of former German professional soldiers who were taking care of soldiers' pension claims, personal problems, etc., and doing staff work now on how former professional soldiers could aid in the defense of the Fatherland upon a Soviet invasion. With more prodding, he gave me the following details:

The "Selbsthilfe" has plans drawn up for the organization now of former soldiers into dormant groups or military formations. In time of hostilities, i.e. Soviet invasion, these soldiers would join Allied forces for the defense of the Fatherland. The Selbsthilfe plan is in four phases:

- 1) The first will be the defense of the land East of the Donau and then withdrawal over the Donau. All former soldiers living East of the Donau would form groups now; activate in time of invasion and join the Allies in defense of that area and withdraw with them over
- 2) The second line of defense, a line running approximately north and south through Stuttgart. Same action as above, to;
- 3) The third line of defense, the Rhine, with same action by groups as above. Then in the worst military situation;
- 4) The withdrawal of Allied troops, the Selbsthilfe organized German groups included, down the Rhine

SECRET
SECURITY INFORMATION

SECRET
SECURITY INFORMATION

- 4 -

valley into Spain.

11. KIBITZ-15, when telling of these plans, gave them his whole-hearted approval as a former German officer and tactician. I tried to elicit a little bit more information on the Selbsthilfe, but was unable to do so. As the rapport of our meeting had gone so nicely up until then, I decided to let the matter drop.

12. A check on ZIPPER and COM files in Frankfurt, plus a talk with [] on 20 October, produced more information on the Selbsthilfe. A summary of the organization and its ideas as reported in our files is as follows:

Its full title is "Soldatenselbsthilfe in Sueddeutschland". It is also known as the South Wurttemberg Officers Group. Leaders of the organization are: former Lt. Col. Albert Paul Schnez of Stuttgart-Gaisburg, Ferher Strasse 12, manager or frontman; former General of Infantry Rudolf von Buenau of Stuttgart, Gaensheide Strasse 62, responsible head of organization.

Schnez has evidently maintained contact with Otto Skorzeny, and with ZIPPER. These contacts were made with the idea of having ZIPPER sponsor the Selbsthilfe's plan (similar to that outlined by KIBITZ-15) for providing the Western military forces with four German divisions four weeks after the outbreak of hostilities. The plan also calls for the evacuation (upon hostilities) of 100-200 former German officers who would be given the task of: a) organizing combat-qualified German males from the streams of refugee into military units to soldier with Allied forces; and, b) other logistical responsibilities in regard to the organization of such divisions. This plan of the Selbsthilfe was forwarded to ZIPPER in the fall of 1951. It was considered and turned down by EUCOM and DYCLAMATIS in April 1952. In the original approach to ZIPPER, the Selbsthilfe and Schnez evidently sold ZIPPER with the idea for ZIPPER requested POB to furnish about 9,000 DM a month for the maintenance of a small Selbsthilfe planning staff. (Ref: MGLA-8343, MGLA-11398 and MGLA-8540.) Skorzeny has given a copy of this defense-of-Germany plan, which is very similar to that of the one proposed by the Selbsthilfe to ZIPPER, (and outlined by KIBITZ-15 above) to the Chief of Station, [] in November 1951 (WSMA-1756, 21 December 1951). An unconfirmed report in COM files also states that Schnez was involved in staybehind recruiting activities in Austria in 1950/51.

At the 20 October German Panel Meeting, the undersigned discussed the Selbsthilfe-ZIPPER relations with [] who said that POB was very interested in the Selbsthilfe and its

SECRET
SECURITY INFORMATION

SECRET
SECURITY INFORMATION

connection to ZIPPER. I requested [] to furnish me additional information on the Selbsthilfe and to have ZIPPER files checked for any reference to KIBITZ-15 himself. (See EGFA-289).

[] was also contacted in regard to the Selbsthilfe and from him it was learned the BfV is also interested in this organization. [] said that the BfV had been checking into Selbsthilfe activities for some time, probably because of its relationships with Skorzeny whom the BfV plans to arrest the next time he arrives in Germany. [] has been requested to elicit further information on the Selbsthilfe from the BfV or from other contacts without giving away the reason for our interest.

13. Another item on the agenda given to me by KIBITZ-15 at our 16 October meeting was the security practices of individual agents and himself. He started off this discussion by comparing our operation with the "BDJ Flap", saying that he did not want to have any "papers" about our operation discovered by the German police. KIBITZ-15 then stated that he had gone through his own personal papers at home and brought to the Heidelberg safehouse or destroyed everything he had concerning the operation. He had also made a point of meeting KIBITZ-150 and seeing that he had destroyed all papers relating to KIBITZ and that he, KIBITZ-150, now kept nothing but what was "in his head". KIBITZ-15 also said that he again contacted KIBITZ-171 to make sure he had destroyed all evidence of our staybehind activities in his possession. A number of papers and notes were picked up from KIBITZ-171. I commended KIBITZ-15 for these acts and said that it had been my contention all along that our security had been lax. He agreed and said that from now on he would personally search all W/T agents, especially after they left a training session to see that they had no incriminating papers in their possession, and furthermore, he would make periodic checks of all agents for the same security reason.

14. We then got down to the point on the agenda entitled "Camouflage or Cover for KIBITZ-15 and Sub-Agents". KIBITZ-15 drew up a paper, which he gave me with the agenda, on his own personal cover and said that it was very difficult in some instances, although he considered that he himself was in no danger. Briefly, he uses the following cover:

- a. His own business connections which call for a great deal of travelling in Germany;
- b. He passes around the word he is a part-time special advisor to the "Blank" Office on military matters which are more or less classified;
- c. He also says that he has press connections. He laughed when he was reading this to me and explained that his "proof" was the occasional small article he contributed to various veteran newspapers currently being published in Germany.

SECRET
SECURITY INFORMATION

SECRET
SECURITY INFORMATION

He followed up this explanation with the proposal that he be given a press pass and cover story that would hold up. He suggested that we obtain a copy of the contract and papers that one of the major wire services gives their indigenous "stringers", and then forge copies with his alias thereon. This, he believed, would be a great advantage to him operationally. I knocked this idea out with a statement that the press as a cover for operations was one of the oldest tricks of the trade and that I certainly was not in favor of it.

He then proposed that he be given a forged paper as a member of the German or International Red Cross; this, I countered, was entirely too dangerous a cover for it was too easy to break. He then proposed that we give him some kind of forged papers showing he had a connection with the German Intelligence Service (Nachrichtendienst) without mentioning any specific one. I immediately said that this type of cover was out of the question first, because there was no such legal agency now and that even if there were, we could ~~not~~ not and would not do such a thing.

15. The next point was one that almost floored me for KIBITZ-15 suggested that all the sub-agents in the KIBITZ-15 Net should now be made to sign a contract. This contract would be in the form of a statement as to exactly what they are doing and why they are doing it. Such contracts would be worded to look as if the agents were recruited and trained by a press service as TWX or telegraph operators, or as reporters for non W/Ters. KIBITZ-15's idea behind this contract was that if any agent was discovered by German authorities, they would be able to say they were "just being trained for employment by such-and-such news service". Thus, there would be no intelligence connotation to their activities. KIBITZ-15 said that he hoped to have such a model contract drawn up in the next couple of weeks and that we could discuss the problem further then. I lost no time in telling him that I approved of the contract idea, but did not approve of the press bureau or training cover story. After this long dissertation on cover ideas by KIBITZ-15, I re-emphasized that the main cover for a staybehind program is the natural cover of each individual agent, explaining to him that in order for a W/T man or any staybehind team member to be stayable, he must live a natural life or cover with his observing and reporting activities being strictly clandestine. This discussion of cover was closed when I genuinely complimented KIBITZ-15 for his consideration of the cover and security problems. He will draft up these "contracts".

16. We then got into a discussion of a number of individual operators and when they would be furnished training and the old sore point of FRQs. With the idea of giving KIBITZ-15 "busy work" for the next couple of weeks, and as a preliminary step in limiting him to a given number of operators and staybehind teams, I requested him to give me a list of: 1) all active agents, W/T operators and others; 2) all agents who could be dropped and the reason

SECRET
SECURITY INFORMATION

SECRET
SECURITY INFORMATION

therefore; 3) all agents who were semi-active, when they could become active or whether they should be dropped. In making this request, I indicated that detailed information was required.

17. It was now close to 2330 hours and our meeting was still very Gemuetlich with KIBITZ-15 really playing the part of the self-confident Colonel. The meeting closed with a number of "Witzen" by KIBITZ-15, who had prepared notes on several new ones he had heard recently.

18. KIBITZ-15's self-confident attitude; his overnight "awakening" to security; his admission that he had connections with the Selbsthilfe who told him of the "BDJ Flap" and his propositioning me for the 14,000 DM, tend to point to the fact that KIBITZ-15 has possibly confessed (to the Selbsthilfe or through them to ZIPPER ??) his sins -- his part in KIBITZ -- in an effort to get some German approval and/or as "Rueckversicherung" in the event some German authorities start an investigation and an ensuing BDJ-type flap. Such a flap (see EGFA-297) would be very detrimental to the pursuit of his military career which is his main ambition. Considering the above, purely in the realm of conjecture, we might ask the following questions:

a. Was KIBITZ-15 told by "someone" that he should continue to cooperate with us as long as he was not exposed; i.e. tighten up his security?

b. Could he also have been told to see whether or not we would furnish large sums of money, (i.e. 14,000 DM) with an eye to having KIBITZ finance, in whole or in part, the Selbsthilfe "planning staff" (see paragraph 12 above)?

HGS/cfp

APPROVED: []

SECRET
SECURITY INFORMATION

**SECRET
SECURITY INFORMATION**

Chief of Mission, Frankfurt

28 October 1952

JJA Chief, FHB

ATTN:

OPERATIONAL/CALL

23 October Meeting with KIBITZ-15

REF: EOFA-344

1. Reference is the contact report on the first meeting (16 October) I had with KIBITZ-15 subsequent to the LGPROWL/Apparat Flap. Because of the security aspects inherent in the KIBITZ-15 Met and the reconsideration of the entire Staybehind Program by COM AND EE, contact reports will be submitted hereafter on each major meeting with KIBITZ-15. This, therefore, will be the second of such series.

2. At the 16 October 1952 meeting with KIBITZ-15, we arranged to meet at the Ula safehouse at 1100 hours, 23 October. Because of the necessity for moving out of the Ula safehouse, this meeting was cancelled and word was sent to KIBITZ-15 through KIBITZ-150, that the meeting would be changed to the Unterschondorf safehouse, same day, same time. Two hours after KIBITZ-15 was due at Unterschondorf, he called from Ula saying that he had had car trouble and that no one had answered the phone at Ula. (I learned later from KIBITZ-15 that he had not heard from KIBITZ-150.) We arranged to meet at the Hotel Augusta in Augsburg at 1600 hours, 23 October. and I proceeded to Augsburg and met KIBITZ-15 as scheduled. Because the meeting took place in the hotel dining room, we stayed only about one hour and did not transact much business.

Rest of the meeting

3. KIBITZ-15 was in quite good spirits and again very self-confident; however, he was interested in only one thing, that of securing the 8,000 DM for KIBITZ-177's rental of the Gasthaus near Hof. (See EOFA-344). In fact, KIBITZ-15 said that he had done nothing since our last meeting except go from one bank or loan agency to another seeking the 8,000 DM for KIBITZ-177. He had had absolutely no success. Each banker stated that KIBITZ-177 could not have a loan because he had no security to put up for such a loan, which is true, or that they would not loan the money for the operation of a Gasthaus because it is "non-productive"; i.e. if he wanted to open up a factory of some sort, he would have a better chance of getting a loan. KIBITZ-15 gave details on all the bankers he saw and their various answers -- all negative.

4. In the meantime, KIBITZ-177 had been to see the present owner of the Gasthaus and was very much enthused about the proposition saying it was a real money-maker. The present owner told KIBITZ-177 that he was sick and

COM-3
EE-3 ✓

**SECRET
SECURITY INFORMATION**

RI COPY

9748

NAZI WAR CRIMES DISCLOSURE ACT

- EXEMPTIONS Section 3(b)
- (2)(A) Privacy
- (2)(B) Methods/Sources
- (2)(G) Foreign Relations

Declassified and Approved for Release
by the Central Intelligence Agency

Date: 2005

SECRET
SECURITY INFORMATION

that he had to sell by the first week in November. KIBITZ-177 told him that he was having difficulty in getting money together and the man very kindly said he would give him first call on the sale up until 1 November, but as of that date, he must have a final answer. The present owner further stated he would have no difficulty at all in selling his lease on the place and KIBITZ-15 readily admitted this. KIBITZ-15 then gave me a detailed report, by KIBITZ-177, on the Gasthaus deal.

5. KIBITZ-15 said that he saw no way that he could get a legal loan for this deal before 1 November. (Upon my indirect questioning, he admitted that he himself did not like to loan KIBITZ-177 the 3,000 DM because of cover reasons.) I was then propositioned in the following manner: Why couldn't I deposit 3,000 DM in a German bank under an alias receiving a deposit slip; then give KIBITZ-177 this deposit slip. KIBITZ-15 said he would fix up all legal technicalities so KIBITZ-177 could borrow another 3,000 DM using my deposit as security. I backed off of this one saying that the cover would be very very bad in such a deal and secondly, that as an American employee of the U.S. Government, I could not invest in any business in Germany without special permission. KIBITZ-15 said, in effect, "Oh, don't worry about that, I (KIBITZ-15) could do it all if you gave me the money." This, I also said was not a very good idea and that anyway I didn't think I could get the authority for such an arrangement before the 1 November deadline. KIBITZ-15, although quite disappointed, said he realized we had too short a time to get the money, but that he would try again to find the money before 1 November.

6. We then discussed KIBITZ-182 who was just finishing up another three weeks' training session. (From what [] and [] KIBITZ-182's R/T instructor, tell me, it appears that KIBITZ-182 has her eye on KIBITZ-15. She, a divorcee, is about five years younger than KIBITZ-15 and was the kid sister of a school friend of KIBITZ-15's. During her last week in training, KIBITZ-182 had mentioned to [] that she would like very much to see KIBITZ-15 again, but had not been able to get in touch with him for some time.) When [] mentioned KIBITZ-182's desire, KIBITZ-15 became flustered for the first time during the meeting. He did not want to see her. We kidded him, of course, quite profusely and he denied that any relationship, other than operational, had ever or would ever exist. He was very emphatic about this, but at the same time, looked somewhat embarrassed.

7. KIBITZ-15 then showed us reports from the Graphologisches Institut (handwriting institute) Heidelberg, on five agents in the KIBITZ-15 Net. KIBITZ-15 had previously told me that he wanted to have the handwriting of a number of his sub-agents analyzed by the Institut saying it was a good way to discern a person's character. When he first mentioned the subject I told him I did not favor it because such an Institut probably had close connections with police agencies. He said that he would send only two or three at a time and send them from his private address as a businessman wanting information on prospective employees. When he showed us the five reports — KIBITZ-171, 182, 150, 137, 156 — on 23 October, I again told him I was not in favor of the idea and that he should not send any more. He halfheartedly agreed.

SECRET
SECURITY INFORMATION

SECRET
SECURITY INFORMATION

- 3 -

8. I then told KIBITZ-15 that as we were forced to give the Ulm safe house back to the Army, we would only have one safehouse for training purposes for the time being. Actually, Ulm Post gave us a new safehouse near Augsburg. However, as another means of cutting down KIBITZ-15's operations, it is planned to keep knowledge of this safehouse from him for the present time. I also told him that we were in the midst of moving the office in Heidelberg and the new place would be all set up by the end of next week. This will give the KIBITZ-15 show just two houses -- the office in Heidelberg and the safehouse at Wessling -- and we will have all "clean" houses. (The safehouse at Unterschondorf is being turned over to WOB in a trade for Wessling. KIBITZ has one other safehouse at Ludwigshurg for the non-KIBITZ-15 agents.)

9. We then discussed KIBITZ-221 who is now in training with [] at Wessling. KIBITZ-15 said he did not know KIBITZ-221 very well, as he had been recruited through KIBITZ-137. KIBITZ-15 said he would like to know him better and we both agreed our next meeting should be at Wessling to meet KIBITZ-221 and discuss routine business. We then arranged to meet in Munich at 1100 hours, 30 October 1952, from where we will proceed to Wessling.

[]

HOG/cfp

APPROVED:

[]

SECRET
SECURITY INFORMATION

VIA: AIR
(SPECIFY AIR OR SEA POUCH)

DISPATCH NO. EGFA-355

SECURITY INFORMATION
SECRET
CLASSIFICATION

TO : Chief, EE

DATE: 30 October 1952

FROM: *JH* Chief, FHB

ATTN:

SUBJECT: GENERAL— OPERATIONAL/CALL

SPECIFIC— ^o Identification of Subject of EGFA-354

1. Subject of PRQ Part I forwarded by EGFA-354, is an old-time East-Zone friend of the second reference in question number 31 of said PRQ Part I. The latter is hereby identified as KIBITZ-225.

2. KIBITZ-225 is employed as manager of KIBITZ-15's farm equipment factory in Buttenwiesen and acts as part-time courier for the KIBITZ-15 Net. KIBITZ-225 does not know, according to KIBITZ-15, exact details of the KIBITZ-15 Net. We will attempt to get a PRQ Part I on KIBITZ-225.

cfp
HGS/cfp

APPROVED: _____

DIST:

EE-3
 COM-3

AM d/c
AB X
IN
PS
DX
DES RFD
FI

CS COPY

SECURITY INFORMATION
SECRET
CLASSIFICATION

FORM NO. 51-28 A
MAR. 1949

NAZI WAR CRIMES DISCLOSURE ACT

Declassified and Approved for Release
by the Central Intelligence Agency
Date: 2003

EXEMPTIONS Section 3(b)

- (2)(A) Privacy
- (2)(B) Methods/Sources
- (2)(G) Foreign Relations

asd

OFFICIAL DISPATCH

VIA: Air DISPATCH NO. EGQW-1610
SPECIFY AIR OR SEA POUCH

SECRET
Security Information
CLASSIFICATION

OCT 30 1952

TO : Chief of Station, Frankfurt DATE: _____
Attn: FHB/E

FROM : Chief, EE

SUBJECT: GENERAL - Operational/CALL
SPECIFIC - KIBITZ 136

Hgh. & Dep. Germany

Provisional operational clearance has been granted Subject.

RW/J1

Date of origin: 27 October 1952

TOP SECRET

AN <i>SLC</i>
AB <i>X</i>
IN
PS
EX
DBS <i>NFD</i>
FI

3	6	1	19/28
ABSTRACT		INDEX	
<i>for</i>			
DATE 5 Nov. 52			

RELEASING OFFICER
EE/FY/PO

COORDINATING OFFICER

AUTHENTICATING OFFICER
EE/FI/G

SECRET
Security Information
CLASSIFICATION

FORM NO. 51-29
JUN 1949

GPO 83-22240

NAZI WAR CRIMES DISCLOSURE ACT

- EXEMPTIONS Section 3(b)
- (2)(A) Privacy
 - (2)(B) Methods/Sources
 - (2)(G) Foreign Relations

Declassified and Approved for Release
by the Central Intelligence Agency
Date: *2005*

OFFICIAL DISPATCH

VIA: Air
SPECIFY AIR OR SEA POUCH

DISPATCH NO. EQW-1629

SECRET
Security Information
CLASSIFICATION

DATE: OCT 30 1952

TO : Chief of Station, Frankfurt
Attn: FHB/ []
FROM : Chief, EE

SUBJECT: GENERAL - Operational/CALL
SPECIFIC - KIBITZ 132

Handwritten signature

Provisional operational clearance has been granted Subject.

Date of origin: 27 October 1952

RW/jl

TOP SECRET

JAN	<i>skc</i>
AB	X
IN	
PS	
BX	
DES	NED
FI	

32	6	1	19/29
ABSTRACT	X	INDEX	
<i>Handwritten marks</i>			
DATE 5 Nov 52			

RELEASING OFFICER
EE/PI/ []

COORDINATING OFFICER

AUTHENTICATING OFFICER
EE/PI/G

SECRET
Security Information
CLASSIFICATION

FORM NO. 51-28
JUN 1949

NAZI WAR CRIMES DISCLOSURE ACT

GPO 63-22240

Declassified and Approved for Release
by the Central Intelligence Agency
Date: 2005

- EXEMPTIONS Section 3(b)
- (2)(A) Privacy
 - (2)(B) Methods/Sources
 - (2)(G) Foreign Relations

AIR

**SECRET
SECURITY INFORMATION**

EGFA- 382

Chief, EE

31 October 1952

Chief, PHB

ATTN: []

ADMINISTRATIVE/CALL

KIBITZ/VULTURE Progress Report for period
1 September to 31 October 1952

1. Project Crypto: KIBITZ/VULTURE
2. Organizational Changes During Period:
Case Officers: No change
Principal Agents: No change
3. Summary of Activity During Period:

a. Spotting and Recruiting: In early September, [] of the Washington REDSOX Desk arrived in Frankfurt and contacted the undersigned to give us leads for possible KIBITZ candidates. (MCQW-11,948, 11 July 1952. reported []'s trip and summarized some of his leads.) [] and [] then met two German friends of []'s. Both reacted favorably to preliminary discussions of possible recruitment. In addition, KIBITZ staff members were directed, in August, to concentrate on spotting and recruiting candidates for U.S. staff controlled part of the Staybehind Program. This spotting activity had begun to bear fruit with a number of candidates being name-checked.

b. W/T Training: In September, W/T training slacked off considerably for two reasons: 1) the normal vacation season was ended and the operator candidates found it difficult to take time off from their everyday pursuits; 2) one W/T instructor took ten days' leave. During the month, only two agents received training -- KIBITZ-173 and KIBITZ-182. KIBITZ-182, 221 and 3 received varying periods of resident W/T training during October.

c. Completed W/T Staybehind Agents: During September and October, an above-ground cache and a burial were made for KIBITZ-6, who finished his W/T training and received his signal plan. KIBITZ-6 is thus our second completed W/T Staybehind Operator (reports are in preparation).

DIST:
EE-3 ✓
COM-3

**SECRET
SECURITY INFORMATION** [] []

COPY

6-9757

NAZI WAR CRIMES DISCLOSURE ACT

- EXEMPTIONS Section 3(b)
- (2)(A) Privacy
 - (2)(B) Methods/Sources
 - (2)(G) Foreign Relations

Declassified and Approved for Release
by the Central Intelligence Agency
Date: 2005

SECRET
SECURITY INFORMATION

- 2 -

d. VULTURE Blind Caches: Subsequent to last Progress Report, one complete blind W/T cache -- VULTURE/N -- was completed.

e. The KIBITZ-15 Net Activities: The LCPROWL/Apparat "flap" of early October, had an apparent salutary effect on KIBITZ-15, engendering in him: 1) noticeable self-confidence; 2) an overnight "awareness" of security; and 3) grandiose ideas on how we should increase our financial support of his Net. However, the undersigned believes that these developments probably have arisen through "arrangements" KIBITZ-15 has made (about the time of the "flap") with some German veteran group or friend in an official position in Bonn to insure that he is not involved in an LCPROWL-type "flap" and/or that his own standing in professional military circles is not endangered by his activities with us. (See EGFA-297, 3uh, 3h5)

During the period we have succeeded in getting KIBITZ-15 to turn in a number of PRQs; really halt recruiting; re-survey the entire Net to ascertain the active agents. This last is a preliminary step in getting KIBITZ-15 to drop from the Net's roster a good number of inactive agents. (Details will be reported on this last point.)

[] , during the reporting period, has supervised KIBITZ-150 in the preparation of four above-ground caches (two are complete) for W/T operators in KIBITZ-15 Net.

f. "Flaps": (1) On 29 August 1952, a German inspector of the Heidelberg Military Post Fire Marshal's Office, visited KIBITZ-15 in the old Heidelberg safehouse. He was quite perturbed that a German was in this American billet; departed and returned a few minutes later with two MPs. Luckily I had arrived just before the MPs and explained that we were legally entitled to live in the billet. To insure that no "flap" would arise, I contacted the S-2 of Heidelberg Military Post and he contacted the Provost Marshall. I had evidently satisfied the MPs for they did not even make a report on the incident.

(2) The CE Desk, COM, notified the undersigned that on 17 October 1952, CIC had notified COM that the Soviets were allegedly running an operation to obtain data on "American house at Kiechelweg 8, Ulm". KIBITZ had formerly occupied (see EGFA-262, COM only) this house which was almost directly behind our present house in Ulm. As we were in the midst of negotiations with Ulm Post to exchange our safehouse (at Galgenbergweg 20) for a "clean" house, we immediately closed down the Ulm house. (See para 3.g. below for subsequent details.) Further investigation by CE Desk disclosed no indication that KIBITZ operations had been compromised; however, investigation is continuing.

g. Administration: Since June, the undersigned has been attempting to exchange the three safehouses used by the KIBITZ-15 Net (Heidelberg, Ulm, Unterschondorf) for other "clean" properties. It appears that we

SECRET
SECURITY INFORMATION

SECRET
SECURITY INFORMATION

- 3 -

have at last succeeded: MOB has assigned a new house at Wessling to KIBITZ, in exchange for the Unterschondorf house which was occupied the middle of October. We have also exchanged the Heidelberg office used by KIBITZ-15 for another similar-type accommodation in Heidelberg. The Ulm safehouse has been returned to the Ulm Military Post in exchange for a house in Augsburg, which will be occupied by KIBITZ in mid-November. The Ludwigsburg safehouse (acquired in August) is being kept for use only by the non-KIBITZ-15 agents.

4. Action Pending:

a. All of our spotting and recruiting activity came to an abrupt halt with the receipt of DIR-22611, 8 October 1952, which put a stop to all KIBITZ recruiting until Washington reviews all Staybehind Programs. A copy of EE's preliminary assessment of the entire KIBITZ program is said to be in the mail. To date, this assessment has not arrived.

*q/kw
has arrived
J.S.*

At Washington's request, EGFA-14936, a re-assessment of the entire KIBITZ Operation was forwarded to Chief EE on 5 September (EGFA-32). Briefly, this re-assessment: 1) recommended that the major effort in the staybehind program should be the recruitment and training of individual U.S. Staff controlled agents; 2) stated that the security, compartmentation and motivation of the KIBITZ-15 Net were not of a high enough operational standard and that the KIBITZ-15 Net should be kept from expanding and considered to be only a second-rate operation whose value in time of hostilities, would be questionable. A further assessment of the KIBITZ-15 Net was made in EGFA-297, in which it was recommended that it be turned over to the German Government or to ZIPPER as soon as practicable.

b. KIBITZ/VULTURE FPO had originally been written to cover period 1 January 1952 through 30 June 1952 believing that, as in the past, approval for the succeeding six months would be automatic. In May and June, we requested project approval for the period January-December 1952 (FRAN-4106) as no FPO approval at all had been received. On 4 July 1952, WASH F-48527 approved project for period 1 January through 30 September 1952 and said that Washington would pouch a fuller explanation. Several memos giving brief re-assessment of the KIBITZ program -- especially KIBITZ-15 Net -- arrived during the summer, but no further word on finances. As of 30 September, KIBITZ had spent approximately one-half of the allotment authorized for the 9-month period 1 January - 30 September 1952, approximately \$14,000. We requested in SFRAN-6784 that Washington authorize the expenditure for the remainder, about \$14,000 (\$29,350.00 was authorized 1 January-30 September) between 1 October and 31 December 1952. EE's approval of our proposal was given 18 October 1952 (DIR-24275).

SECRET
SECURITY INFORMATION

SECRET

SECURITY INFORMATION

- 4 -

c. Preparation of a new FPO (for calendar year 1953) will be made during November, but our final FPO proposal will necessarily have to await the results of EE's re-assessment of the KIBITZ Project.

5. Account of Expenditures and/or Obligations Incurred: The KIBITZ/VULTURE Project expended and/or obligated for operational and overhead expenses, during:

September	7,527.84	DM	89.97	MPC
October	9,055.77	DM	90.00	MPC

6. Outstanding Financial Advances as of 31 October 1952:

9,706.59	DM	58.19	MPC
----------	----	-------	-----

7. Recommendations and Comments: None

APPROVED:

SECRET

SECURITY INFORMATION

32-6-2-9751

1 November 1952

Herrn Ernst Roeder
Wessling Obb., OAD

Dear Herr Roeder:

Herewith you are offered a position as house-master/stoker/
gardener for the salary of DM 100.00 per month. Your place of work
is Wessling Obb., OAD Community 43.

Out of this salary you are to pay the following: 1) income tax;
2) church tax; 3) all other taxes; 4) all payments for insurance --
health insurance, veterans benefits, etc. Your tax card and insurance
receipts are to be produced upon demand.

Your duties as house-master/stoker/gardener are: 1) the care of
the heating of the house; 2) the general maintenance and care of house
and grounds and 3) when necessary, assistance to the housekeeper and
other similar duties at the request of the occupants. You are to work
on a half day basis, that is, to adjust your working day so that you
can attend to your furnace duties. You may otherwise arrange your work
upon agreement with occupants.

You will accrue one-half day's leave for each month or part of
month worked. You may take this leave upon agreement with Mr. Kaufmann,
your supervisor. You will receive no other benefits from your employer
in respect to this employment.

Termination of this employment contract can be made by either
party upon receipt of 30 days' notice. This does not preclude, however,
your dismissal without such notice for cause.

This contract is effective 1 November 1952 for an indefinite
period. The first salary payment will be made on 1 December 1952.
Thereafter you will be paid on the 1st of each month.

If you accept this employment offer, please sign your name and
date where indicated.

Accepted:

Name:

Date:

NAZI WAR CRIMES DISCLOSURE ACT

EXEMPTIONS Section 3(b)
(2)(A) Privacy
(2)(B) Methods/Sources
(2)(G) Foreign Relations

Declassified and Approved for Release
by the Central Intelligence Agency
Date: 2005

1 November 1952

Herrn Ernst Roeder
Wessling, Obb.

Sieber Herr Roeder:

Hiermit wird Ihnen eine Stellung als Hausmeister/Heizer/Gartener an Gehalt DM 100.00 monatlich angeboten. Ihr Arbeitsplatz ist: Wessling, Obb., OAD Community #43. Aus diesem Lohn sollen Sie folgendes bezahlen: 1) Einkommensteuer; 2) Kirchensteuer; 3) sonstige Steuern; 4) alle Beiträge für Verisierung, Krankenkasse, Sorgungsamt, usw. Steuerkarte und Versicherungsscheine sind auf Verlangen vorzuzeigen.

Ihre Pflichten als Hausmeister/Heizer/Gartener sind: die Verpflegung der häuslichen Heizung, die allgemeine Erhaltung und Pflege des Hauses und der Gründe, wönstig Mithilfe der Haushälterin, und lediglich sonstige gleichsame Aufgaben auf Befehl der Inhaber. Sie sollen halbtäglich arbeiten, d.h., den Arbeitstag so zu teilen, dass Sie am besten die Heizung nachsehen können. Sonst dürfen Sie Ihre Arbeit mit Verabredung der Inhaber den beiden Parteien günstig regeln.

Für jeden Monat bzw. Monatsteil haben Sie einen Halbentag Urlaub den Sie nach Verabredung mit Mr. Kaufmann nehmen dürfen. Es gibt keine weitere Vergünstigungen.

Kündigung steht beiden Parteien frei. Benachrichtigung erfolgt 30 Tage vorher. Auch ohne Kündigung kann Entlassung erfolgen, wenn triftige Gründe vorliegen.

Dieser Kontrakt beginnt am 1 November 1952. Erste Gahaltzahlung am 1 Dezember 1952, weitere am ersten jedes Monats. Falls Sie diese Stellung annehmen, unterzeichnen Sie bitte mit Datum wo angegeben.

ANGENOMMEN:

NAME:

Richter

DATUM:

20.11.52.